

Kinghelm®

REV. LTR.	DATE	REV.	REVISION REASON	DATE
-----------	------	------	-----------------	------

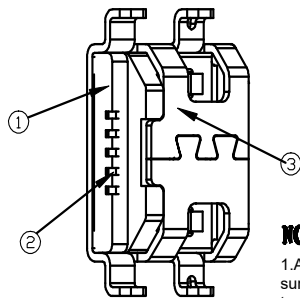
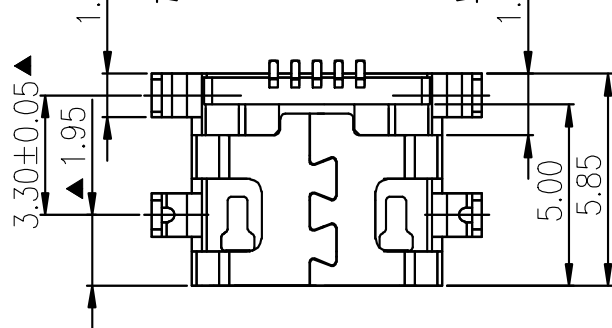
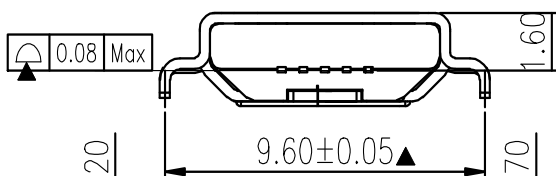
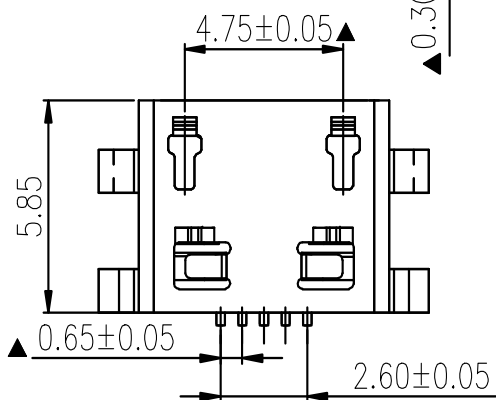
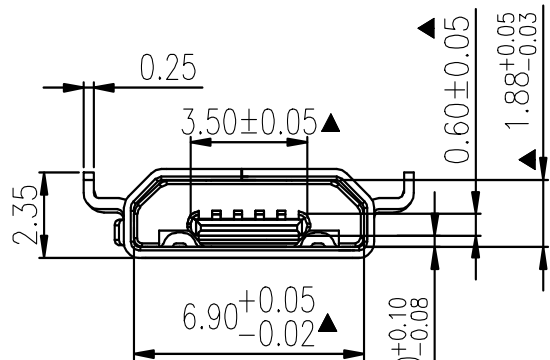

NOTES:

1. According to the functionality requirements, the surface of the finished product shall be free of terminal crushing and plastic burrs.
2. The inspection shall lay emphasis on the dimension marked with "▲".
3. If the dimensional tolerance is unspecified, the free tolerance shall prevail.
4. The flatness of finished terminals must be 100% tested.
5. Seam strength: 1.0KgMin

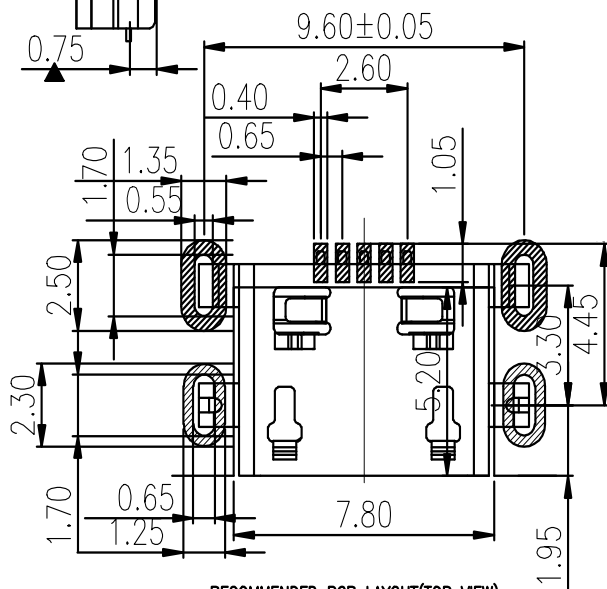
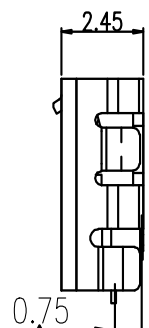

RECOMMENDED PCB LAYOUT(TOP VIEW)
GENERAL TOLERANCES:±0.05

Specifications:

Electrical:

1. Current Rating
1.8A/contact terminal
2. Voltage Rating
30V DC
3. Contact Resistance
50 milliohms MAX
4. Dielectric Withstanding Voltage:
300 V AC AT Sea Level
5. Insulation Resistance:
100MEGA ohms MIN

Mechanical:

1. Connector Mate and Unmate Force
Mate force:3.0kgf(MAX)
Unmate force:0.7kgf(MIN)
2. 5000 times

Material:

1. Housing:
Hing Temperature Thermoplastic
UL 94V-0 LCP Black
2. C5191 EH
3. Shell: H65 EH

Finish:

1. Contact: Plated Gold in Mating Area;
Tin On Solder Tails
2. Shell:
Nickel Plating

Can automatically load tin after passing through the furnace

表面处理 PLATING	GENERAL TOLERANCES			品名 TITLE
	I	II	III	
料厚 THICKNESS	±0.01	±0.02	±0.03	料号 P/N NO.
材料 MATERIAL	±0.05	±0.10	±0.12	图号 Dwg. No.
	±0.10	±0.15	±0.20	图名 Dwg. Name
	±0.5°	±1.0°	±2.0°	页次 Sheet
	版次 REV.	A/0	单位 UNIT	规格 FILE NAME
	比例 SCALE	1:1	单位 UNIT	页次 Sheet

品名 TITLE	MICRO USB DP B TYPE 沉板0.8MM 沉脚脚 平口	SHENZHEN KINGHELM ELECTRONIC CO., LTD.
料号 P/N NO.	XXXXXXXX	WWW.BDS666.COM
图号 Dwg. No.		KH-MICRO0.8CB-5PI
图名 Dwg. Name		0755-83044319
页次 Sheet	1/1	规格 FILE NAME