

Edition	Change content	Date
1	Add material number description	2015/1/28

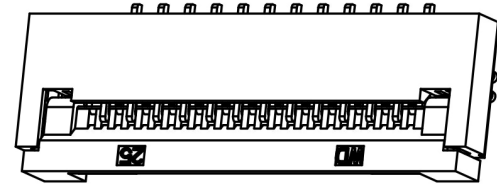

Serial Number	Designation	Material
①	0.5 Third-generation ZIF Rubber Core	LCP UL94V-0 Natural Colour
②	0.5 Third-generation ZIF Upper Terminal	Phosphor Bronze/Tin-plating Surface
③	0.5 Third-generation ZIF Rear Cover	LCP UL94V-0 Black
④	0.5 Third-generation ZIF Soldering Terminal (H=2.0)	Brass/Tin-plating Surface

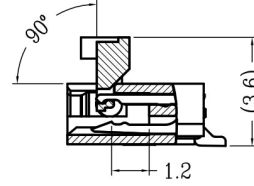
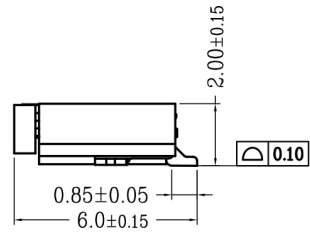
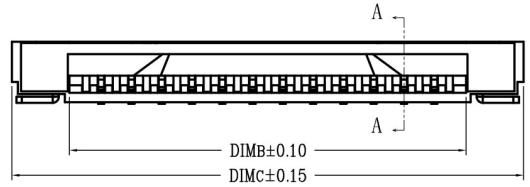

SECTION A-A

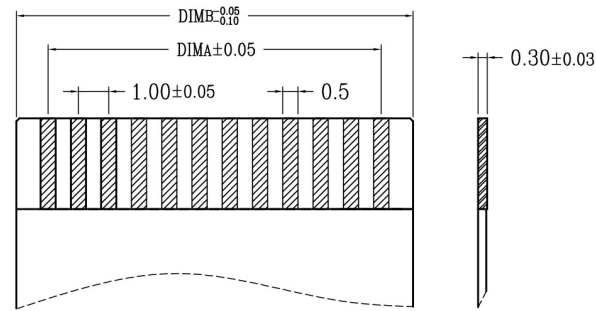
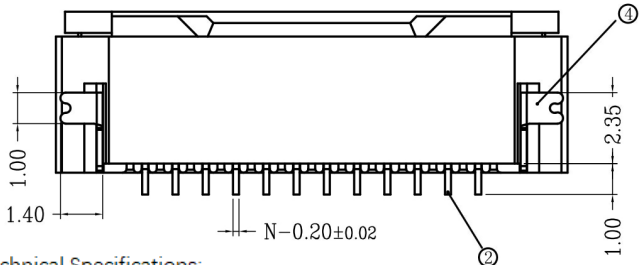

CKT	DIMA	DIMB	DIMC
4	3.00	5.10	8.90
5	4.00	6.10	9.90
6	5.00	7.10	10.90
7	6.00	8.10	11.90
8	7.00	9.10	12.90
9	8.00	10.10	13.90
10	9.00	11.10	14.90
11	10.00	12.10	15.90
12	11.00	13.10	16.90
13	12.00	14.10	17.90
14	13.00	15.10	18.90
15	14.00	16.10	19.90
16	15.00	17.10	20.90
17	16.00	18.10	21.90
18	17.00	19.10	22.90
19	18.00	20.10	23.90
20	19.00	21.10	24.90
21	20.00	22.10	25.90
22	21.00	23.10	26.90
23	22.00	24.10	27.90
24	23.00	25.10	28.90
25	24.00	26.10	29.90
26	25.00	27.10	30.90
27	26.00	28.10	31.90
28	27.00	29.10	32.90
29	28.00	30.10	33.90
30	29.00	31.10	34.90

Technical Specifications:

- The surface of plastic parts shall be smooth without burrs and obvious shrinkage, defects, cracks, etc.
- Temperature Range: - 25 ° C ~ 85 ° C
- Rated Voltage: 50V, AC/DC (Equivalent).
- Contact Resistance: ≤ 0.03Ω
- Insulation Resistance: ≥ 500MΩ
- material number:

XW10202-**-**-**

NO OF CKT (Item Pin)

- Plating
 0: Fully Tin-plated Terminal
 1: Fully Gold-plated Terminal (G/F OVERALL)
 5: Semi-Gold-Tin-Plated Terminal

- Packaging
 T: Tube Packing
 R: TAPE & REEL Packing

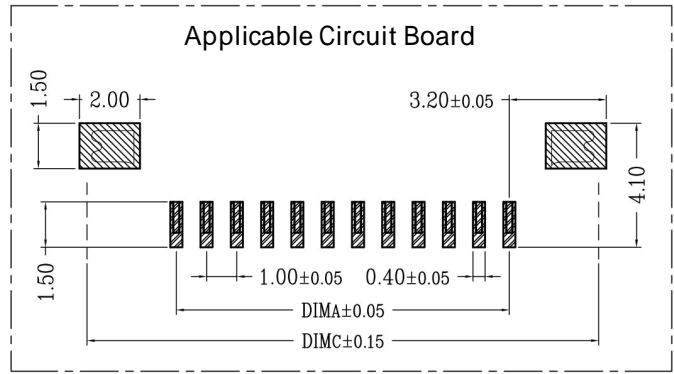

Applicable Flat Wire

General Tolerance
X ±.50 XX ±.10
Y ±.20 XXX ±.05
ANGLES ±1°

SHENZHEN KINGHELM ELECTRONIC CO., LTD		WWW.BDS666.COM	
KH-FG1.0--H2.0-8PIN		0755-83044319	
TITLE		DR	
0.5 Pitch Third-generation ZIF R/A Upper Connector (H=2.0)		Anlan	
DWG NO.		CHKD	
X10202-****-**-**		Wang Tao	
Scale		APPD	
1:1	Unit: mm	HUANG ZHIMING	
SHEET		SIZE	
1 OF 1		A4	
REV		1	