

Approval sheet

**FEATURES**

1. Surface Mounted Devices with a small dimension of 3.2 X 1.6 X 0.6 mm<sup>3</sup> meet future miniaturization trend.
2. LTCC process.
3. High stability in Temperature / Humidity Change.
4. Superb performance to place on the middle of PCB edge and excellent peak/ average gain observed by field test application.

**APPLICATIONS**

1. ISM Band 2.4GHz applications.
2. Bluetooth..

**CONSTRUCTION**

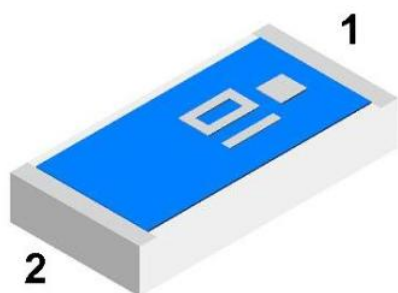

PIN	Connection
1	Feeding
2	Soldering terminal

**DIMENSIONS**

Figure	Symbol	Dimension (mm)
	L	3.10 ± 0.20
	W	1.60 ± 0.20
	T	0.60 ± 0.10
	A	0.25 ± 0.20

## SOLDER LAND PATTERN DESIGN

### Type-1: Empty Space 8.0mm x 3.0 mm

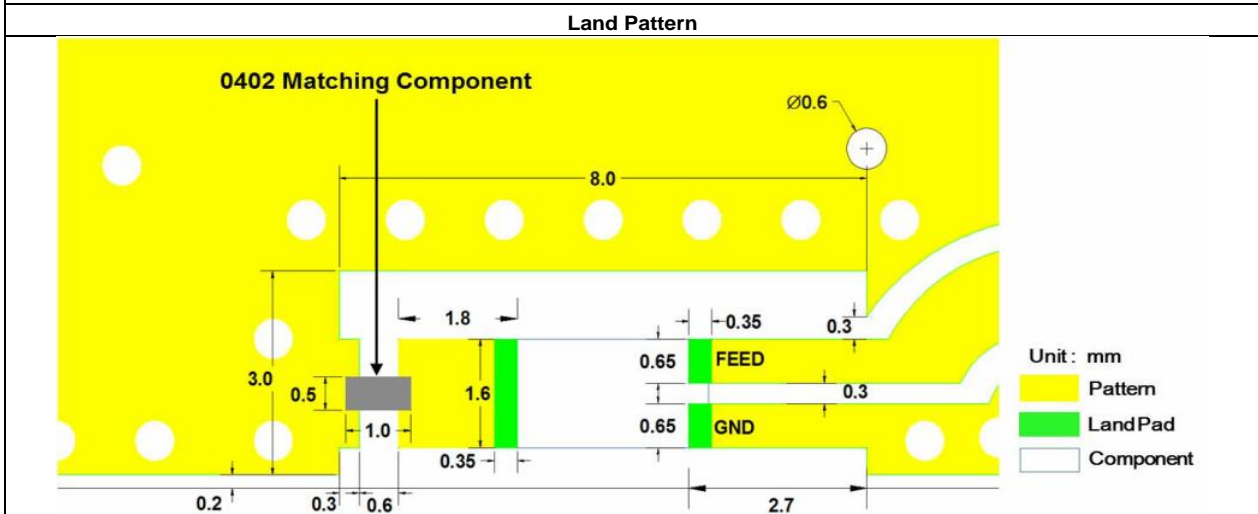
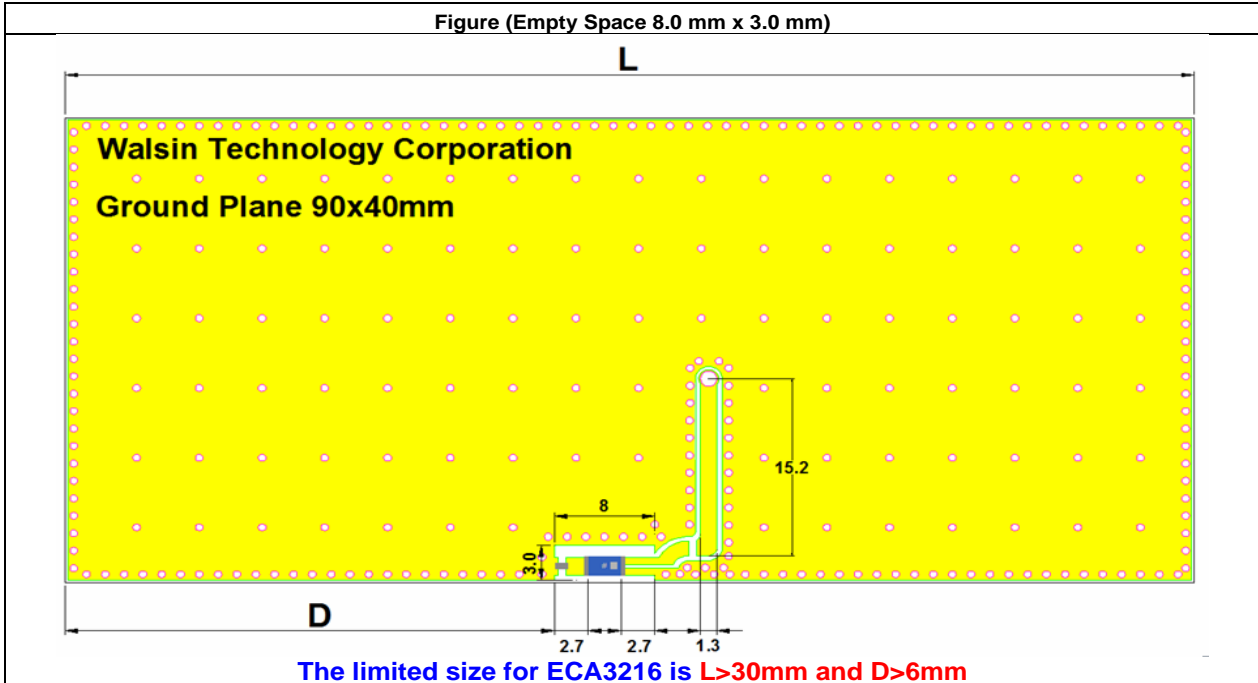

## TYPE-1 TEST BOARD ELECTRONIC CHARACTERISTICS

Item	Specification
Working Frequency Range	2.4GHz~2.4835GHz (Note-1)
Gain	2 dBi (Typical)
VSWR	2.0 max.
Polarization	Linear
Azimuth Beamwidth	Omni-directional
Impedance	50Ω
Power Capacity	3 W max.
Maximum Input Power	5 Watts for 5 minutes

\*Note 1. Central Frequency should be defined after customers' application approval.

**Type-2: Empty Space 6.3mm x 4.0 mm**

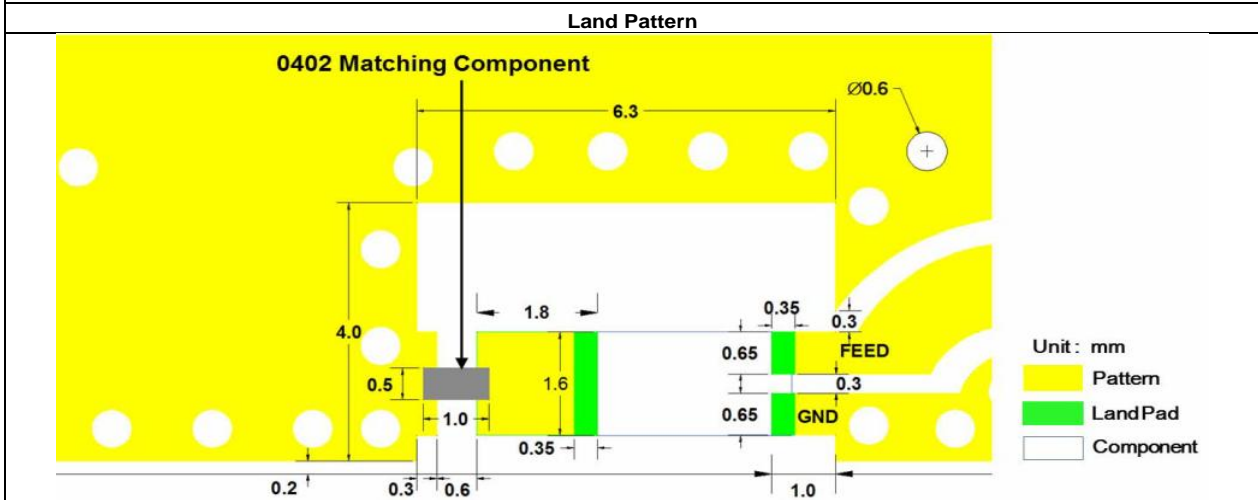
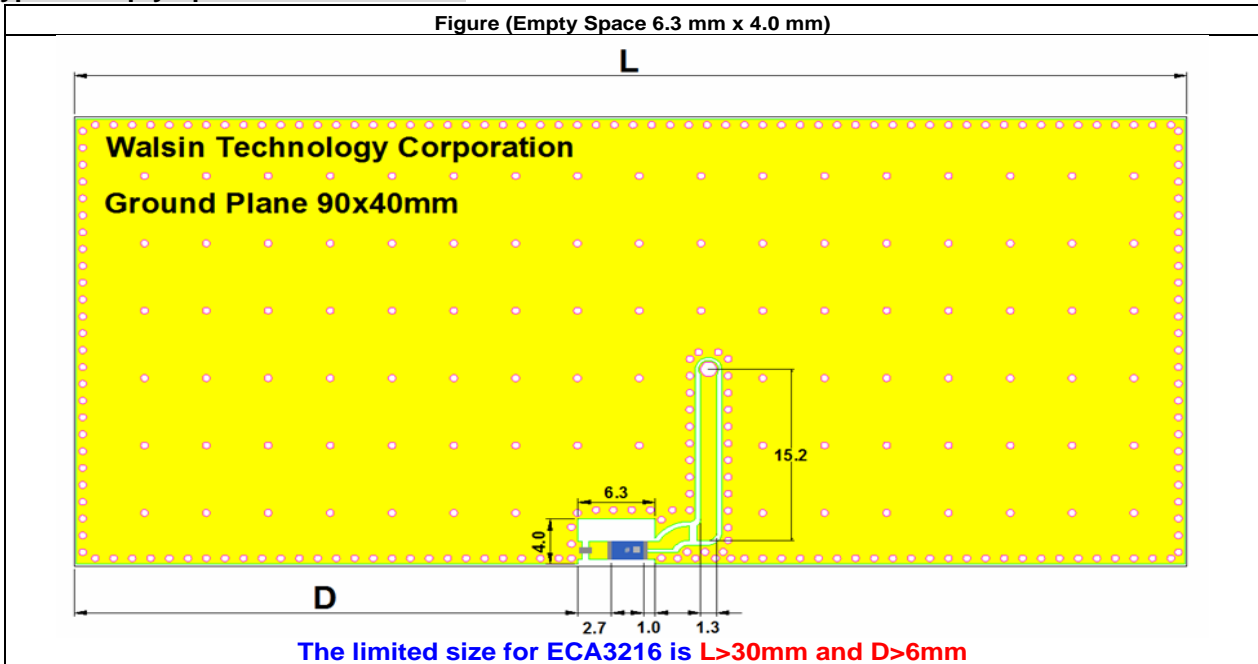

**TYPE-2 TEST BOARD ELECTRONIC CHARACTERISTICS**

Item	Specification
Working Frequency Range	2.4GHz~2.4835GHz (Note-1)
Gain	2 dBi (Typical)
VSWR	2.0 max.
Polarization	Linear
Azimuth Beamwidth	Omni-directional
Impedance	50Ω
Power Capacity	3 W max.
Maximum Input Power	5 Watts for 5 minutes

\*Note 1. Central Frequency should be defined after customers' application approval.

Approval sheet

Antenna on Type-1 Test Board ( Empty Space 8x3 mm & Thick ness 0.8mm)

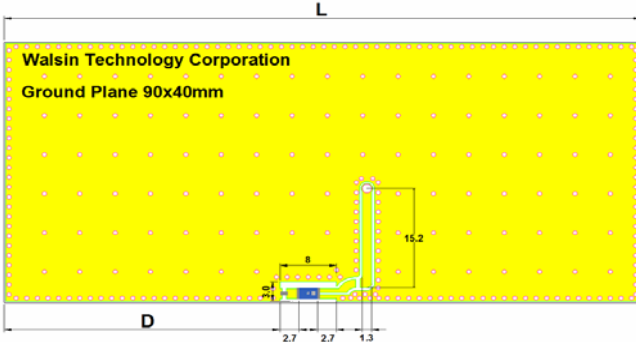

Antenna S11 on Type-1 Test Board

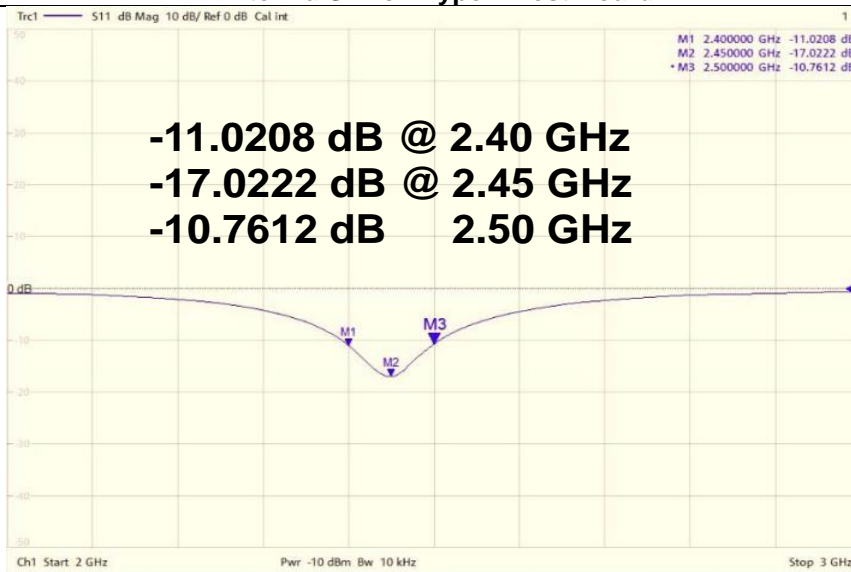

Antenna VSWR on Type-1 Test Board

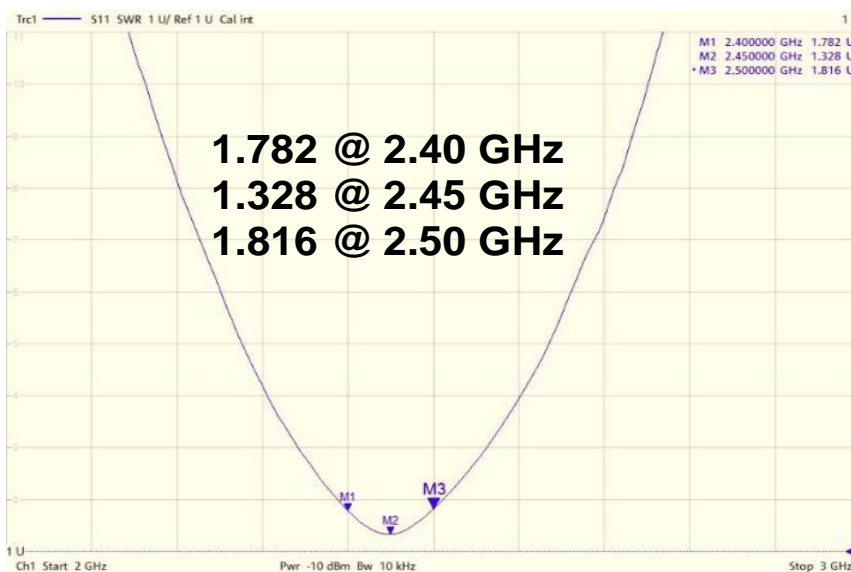

Approval sheet

Antenna on Type-2 Test Board ( Empty Space 6.3x4 mm &Thick ness 0.8mm)

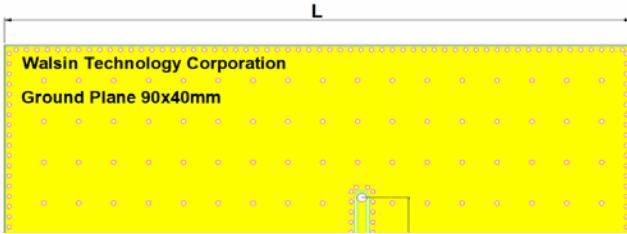

Antenna S11 on Type-2 Test Board

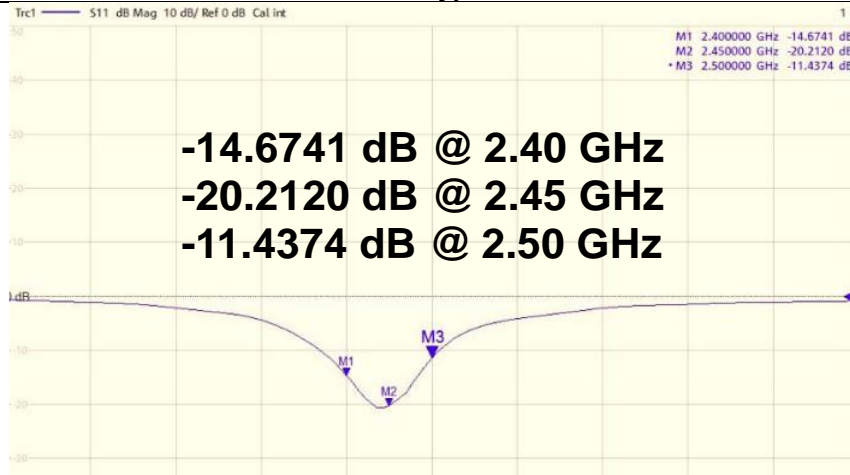

Antenna VSWR on Type-2 Test Board



Approval sheet

**RADIATION PATTERN**

Radiation Pattern and Gain were dependent on measurement board design. The specification of RFECA3216060A1T antenna was measured based on the PCB size and installation position as shown in the below figure Test Board.

**Antenna on Type-1 Test Board**

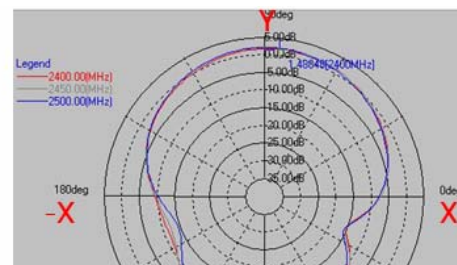
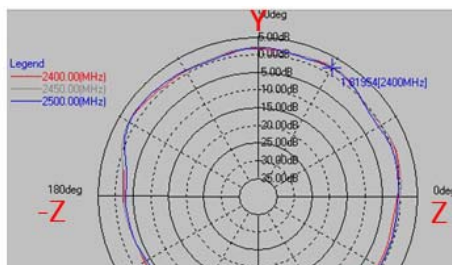
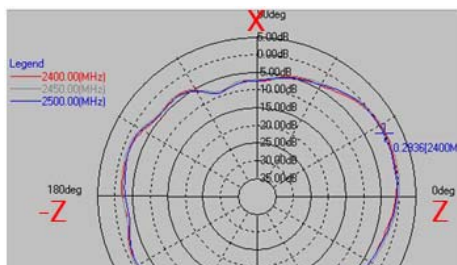
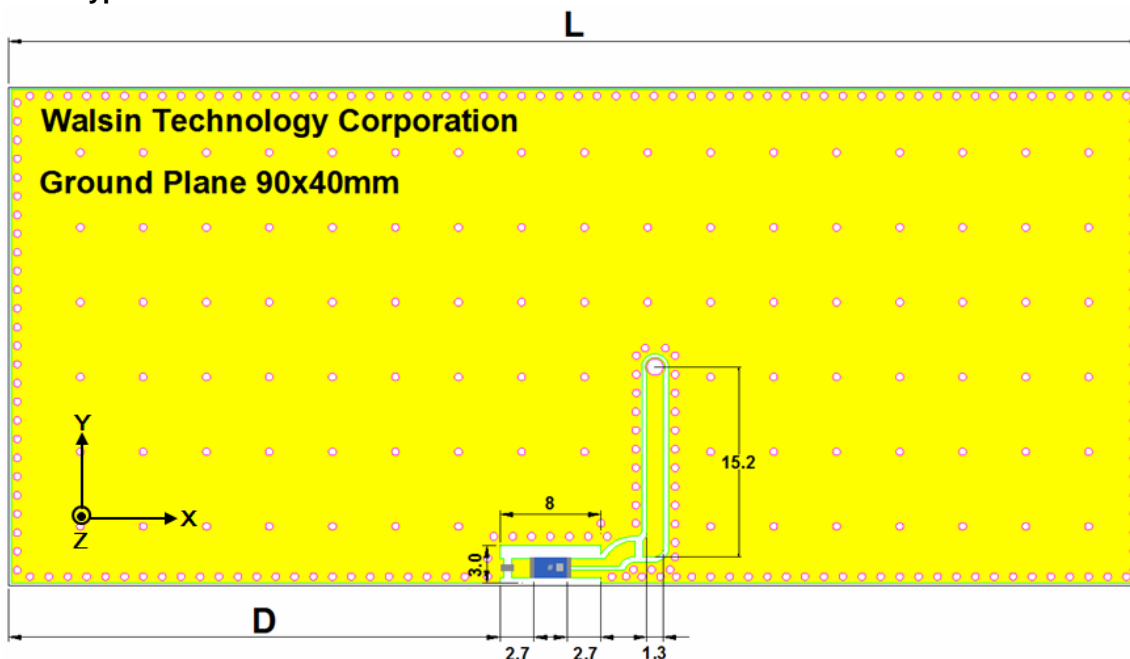

Frequency [MHz]	ZX plane		ZY plane		XY plane	
	Max Value [dB]	Average [dB]	Max Value [dB]	Average [dB]	Max Value [dB]	Average [dB]
2400	0.29	-3.32	1.82	-0.51	1.49	-2.87
2450	0.55	-2.88	2.09	-0.21	1.95	-2.48
2500	-0.15	-3.44	1.82	-0.62	1.82	-2.73

Approval sheet

Antenna on Type-2 Test Board

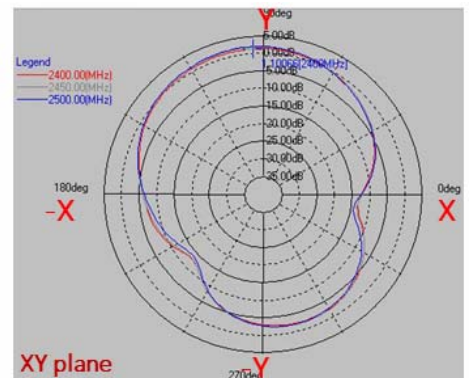
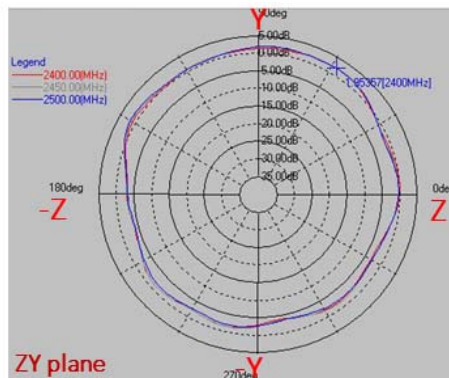
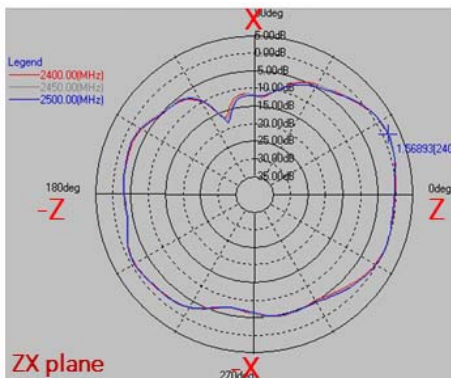
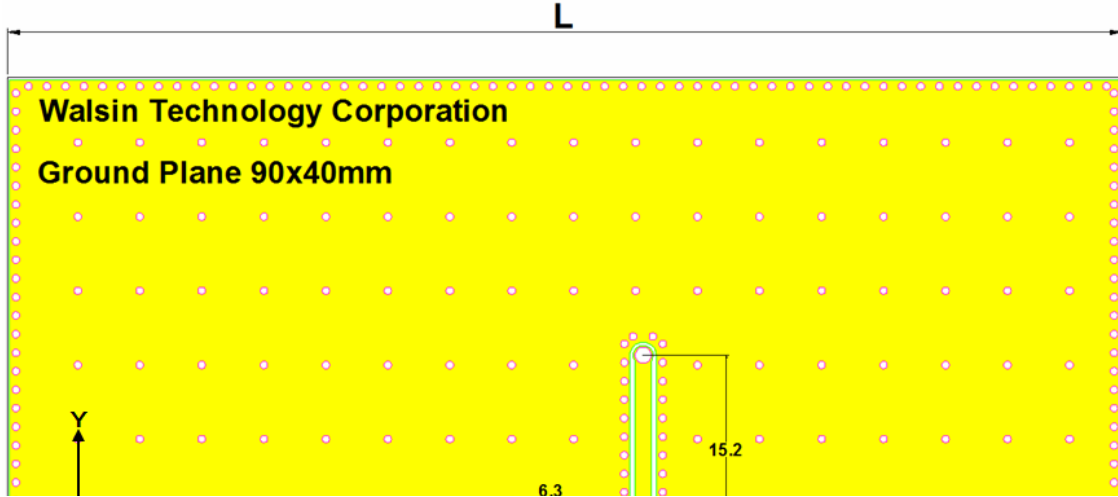

Frequency [MHz]	ZX plane		ZY plane		XY plane	
	Max Value [dB]	Average [dB]	Max Value [dB]	Average [dB]	Max Value [dB]	Average [dB]
2400	1.57	-2.83	1.95	-0.76	1.10	-2.93
2450	1.70	-2.62	2.02	-0.62	1.57	-2.61
2500	1.46	-2.82	1.90	-0.71	1.75	-2.68

Approval sheet

RELIABILITY TEST

Test item	Test condition / Test method	Specification
Solderability JIS C 0050-4.6 JESD22-B102D	*Solder bath temperature : $235 \pm 5^{\circ}\text{C}$ *Immersion time : $2 \pm 0.5$ sec Solder : Sn3Ag0.5Cu for lead-free	At least 95% of a surface of each terminal electrode must be covered by fresh solder.
Leaching (Resistance to dissolution of metallization) IEC 60068-2-58	*Solder bath temperature : $260 \pm 5^{\circ}\text{C}$ *Leaching immersion time : $30 \pm 0.5$ sec Solder : SN63A	Loss of metallization on the edges of each electrode shall not exceed 25%.
Resistance to soldering heat JIS C 0050-5.4	*Preheating temperature : $120\sim 150^{\circ}\text{C}$ , 1 minute. *Solder temperature : $270\pm 5^{\circ}\text{C}$ *Immersion time : $10\pm 1$ sec Solder : Sn3Ag0.5Cu for lead-free Measurement to be made after keeping at room temperature for $24\pm 2$ hrs	No mechanical damage. Electrical specification shall satisfy the descriptions in electrical characteristics under the operational temperature range within $-40 \sim 85^{\circ}\text{C}$ . Loss of metallization on the edges of each electrode shall not exceed 25%.
Drop Test JIS C 0044 Customer's specification.	*Height : 75 cm *Test Surface : Rigid surface of concrete or steel. *Times : 6 surfaces for each units ; 2 times for each side.	No mechanical damage. Electrical specification shall satisfy the descriptions in electrical characteristics under the operational temperature range within $-40 \sim 85^{\circ}\text{C}$ .
Vibration JIS C 0040	*Frequency : $10\text{Hz}\sim 55\text{Hz}\sim 10\text{Hz}(1\text{min})$ *Total amplitude : 1.5mm *Test times : 6hrs.(Two hrs each in three mutually perpendicular directions)	No mechanical damage. Electrical specification shall satisfy the descriptions in electrical characteristics under the operational temperature range within $-40 \sim 85^{\circ}\text{C}$ .
Adhesive Strength of Termination JIS C 0051- 7.4.3	*Pressurizing force : $5\text{N}(\leq 0603)$ ; $10\text{N}( >0603)$ *Test time : $10\pm 1$ sec	No remarkable damage or removal of the termination.



Approval sheet

<p>Bending test JIS C 0051- 7.4.1</p>	<p>The middle part of substrate shall be pressurized by means of the pressurizing rod at a rate of about 1 mm/s per second until the deflection becomes 1mm/s and then pressure shall be maintained for 5±1 sec. Measurement to be made after keeping at room temperature for 24±2 hours</p>	<p>No mechanical damage. Electrical specification shall satisfy the descriptions in electrical characteristics under the operational temperature range within -40 ~ 85°C.</p>
<p>Temperature cycle JIS C 0025</p>	<p>1. 30±3 minutes at -40°C±3°C, 2. 10~15 minutes at room temperature, 3. 30±3 minutes at +85°C±3°C, 4. 10~15 minutes at room temperature, Total 100 continuous cycles Measurement to be made after keeping at room temperature for 24±2 hrs</p>	<p>No mechanical damage. Electrical specification shall satisfy the descriptions in electrical characteristics under the operational temperature range within -40 ~ 85°C.</p>
<p>High temperature JIS C 0021</p>	<p>*Temperature : 85°C±2°C *Test duration : 1000+24/-0 hours Measurement to be made after keeping at room temperature for 24±2 hrs</p>	<p>No mechanical damage. Electrical specification shall satisfy the descriptions in electrical characteristics under the operational temperature range within -40 ~ 85°C.</p>
<p>Humidity (steady conditions) JIS C 0022</p>	<p>*Humidity : 90% to 95% R.H. *Temperature : 40±2°C *Time : 1000+24/-0 hrs. Measurement to be made after keeping at room temperature for 24±2 hrs ※ 500hrs measuring the first data then 1000hrs data</p>	<p>No mechanical damage. Electrical specification shall satisfy the descriptions in electrical characteristics under the operational temperature range within -40 ~ 85°C.</p>
<p>Low temperature JIS C 0020</p>	<p>*Temperature : -40°C±2°C *Test duration : 1000+24/-0 hours Measurement to be made after keeping at room temperature for 24±2 hrs</p>	<p>No mechanical damage. Electrical specification shall satisfy the descriptions in electrical characteristics under the operational temperature range within -40 ~ 85°C.</p>

Approval sheet

**SOLDERING CONDITION**

Typical examples of soldering processes that provide reliable joints without any damage are given in Fig 2

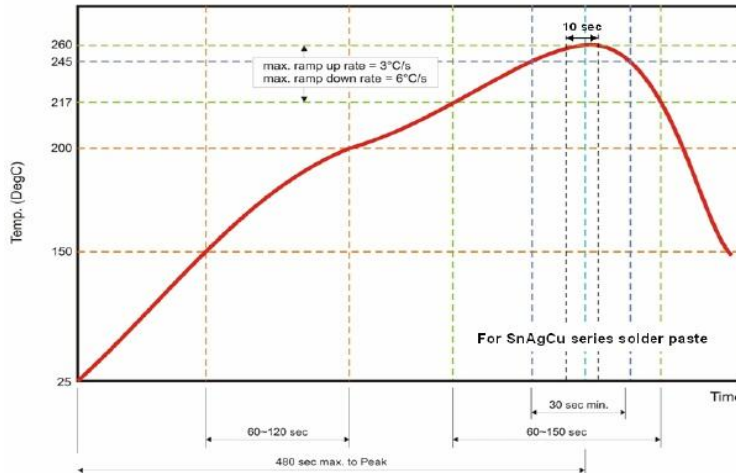

Fig 2. Infrared soldering profile

**ORDERING CODE**

<b>RF</b>	<b>ECA</b>	<b>321606</b>	<b>0</b>	<b>A</b>	<b>1</b>	<b>T</b>
<b>Walsin</b> RF device	<b>Product code</b> ANT : Antenna	<b>Dimension code</b> Per 2 digits of Length, Width, Thickness : e.g. : 321606 = Length 32, Width 16, Thickness 06	<b>Unit of dimension</b> 0 : 0.1 mm 1 : 1.0 mm	<b>Application</b> A : 2.4GHz ISM Band	<b>Specification</b> Design Code	<b>Packing</b> T : Reeled

Minimum Ordering Quantity: 2000 pcs per reel.

**PACKAGING**

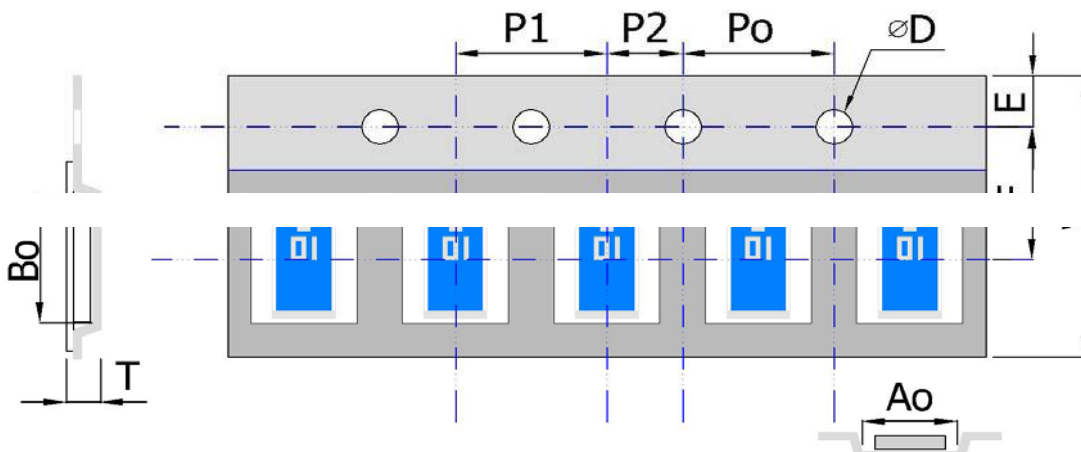

Plastic Tape specifications (unit :mm)

Index	Ao	Bo	ΦD	T	W
Dimension (mm)	1.85 ± 0.10	3.45 ± 0.10	1.55 ± 0.05	0.75 ± 0.10	8.00 ± 0.30
Index	E	F	Po	P1	P2
Dimension (mm)	1.75 ± 0.10	3.50 ± 0.05	4.00 ± 0.10	4.00 ± 0.10	2.00 ± 0.10

## Approval sheet

### Reel dimensions

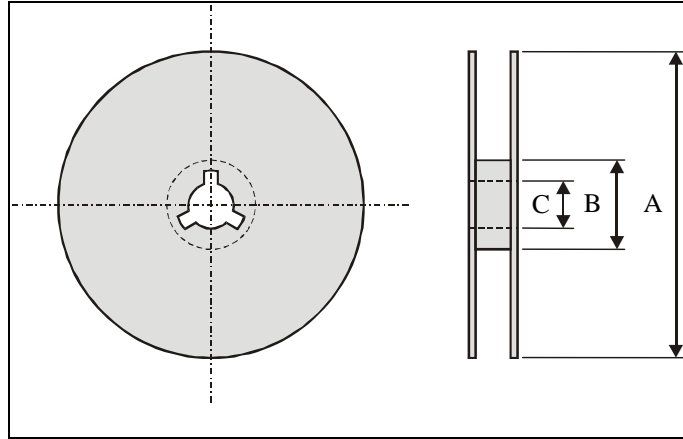

Index	A	B	C
Dimension (mm)	Φ178.0	Φ60.0	Φ13.0

Taping Quantity:2000 pieces per 7" reel

### CAUTION OF HANDLING

#### Limitation of Applications

Please contact us before using our products for the applications listed below which require especially high reliability for the prevention of defects, which might directly cause damage to the third party's life, body or property.

- (1) Aircraft equipment
- (2) Aerospace equipment
- (3) Undersea equipment
- (4) Medical equipment
- (5) Disaster prevention / crime prevention equipment
- (6) Traffic signal equipment
- (7) Transportation equipment (vehicles, trains, ships, etc.)
- (8) Applications of similar complexity and /or reliability requirements to the applications listed in the above.

#### Storage condition

- (1) Products should be used in 6 months from the day of WAL SIN outgoing inspection.
- (2) Storage environment condition.
  - Products should be storage in the warehouse on the following conditions.
  - Temperature : +5 to +40°C
  - Humidity : 30 to 70% relative humidity
  - Don't keep products in corrosive gases such as sulfur. Chlorine gas or acid or it may cause oxidization of electrode, resulting in poor solderability.
  - Products should be storage on the palette for the prevention of the influence from humidity, dust and son on.
  - Products should be storage in the warehouse without heat shock, vibration, direct sunlight and so on.
  - Products should be storage under the airtight packaged condition.