

specification

1. Rated voltage and current: 300V 12A(CE)
2. Insulation Strength: AC2000V/MIN
3. Insulation Resistance: 500MΩ or more at DC500V
4. Operating Temperature: -40 /+105
5. Storage condition: Under 85% humidity at normal temperature, shelf life: 1 year.

Materials and dimensions

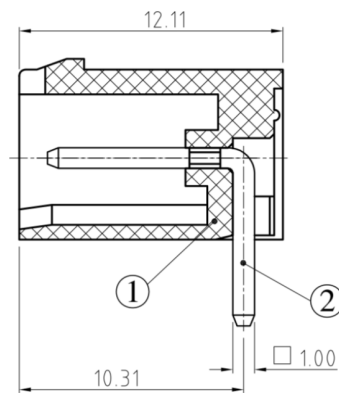
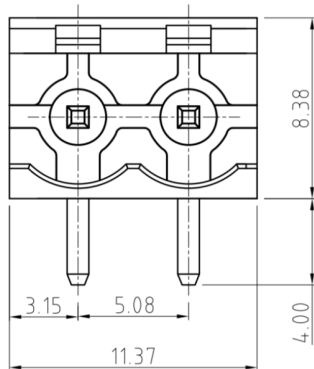

#Use of recycled material 30%

NO.	Designation	Materials	Specification
1	HOUSING	PA66(UL94V-0)	YELLOW
2	PIN	BRASS	EP-Cu/Cu1-2 Sn2-4um

Type selection

Insertion-withdrawal type(Receptacle)

Serial code : Sequence code : feature code : Identifivne code

Z|B|F - **4|0|0|R** - **0|2|P** - **G**

Colour code: G - green The subdivision codes for standard colours may be omitted
 Qty of cables (XXP)
 R: Inline direction and pin level
 serial number serial number for specification classification
 Spacing code, 4-5.08mm
 2B-company code K-Plug-in type (Plug)

Packaging:

Package size: 20.0×19.0 (cm)

SHENZHEN KINGHELM
ELECTRONIC CO., LTD.

www.BDS666.COM

KH-ZBF4000R-7P-5.08G

0755-83044319