

**P. C. B. ZBK-200 SERIES ZBK200R-XXP-XS(15EDG-3. 81(Plug)**

specification

1. Rated voltage and current: 300V 8A(CE)
2. Insulation Strength: AC1500V/MIN
3. Insulation Resistance: 500MΩ or more at DC500V
4. Operating Temperature: -40 /+105
5. Twisting force: 0.2N.m/Max
6. Wire size: 14-24AWG
7. Storage condition: Under 85% humidity at normal temperature, shelf life: 1 year.

Materials and dimensions

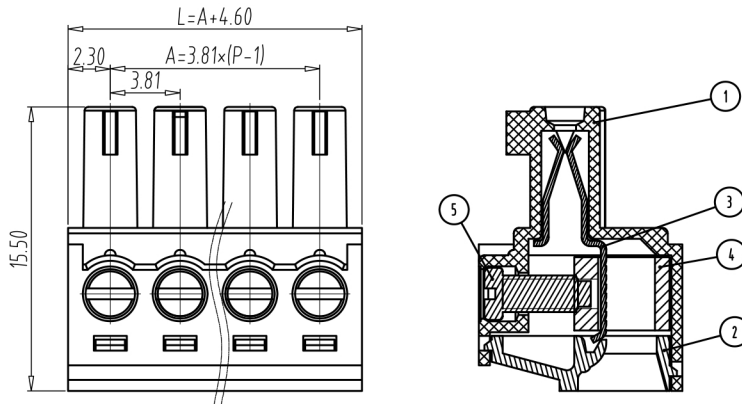

#Use of recycled material ≤ 30%

NO.	Designation	Materials	Specification
1	HOUSING	PA66(UL94V-0)	
2	COVER	PA66(UL94V-0)	
3	CLAMP	BRONZE	EP-Cu/Cu1-2 Ni2-4um
4	BLOCK	BRASS	EP-Cu/Cu1-2 Ni2-4um
5	SCREW	STEEL	M3.0EP-Fe/Cu1-2 Zn5-8um

Type selection

**Insertion-withdrawal type(Receptacle)**

Serial code	Sequence code	feature code	Identifivng code
<b>ZBK</b>	<b>200R</b>	<b>XXP</b>	<b>XS</b>

Screw specification : s-character  
 Colour code :X-(unspecified)  
 Qty of cables ( XXP unspecified )  
 R. Inline direction and insertion Direction level  
 Serial number for specification classification  
 Spacing code: 2-3.81mm  
 ZB- Company Code , K-Insertion-withdrawal type(Plug)

Packaging:  
Package size: 20.0×19.0 (cm)

SHENZHEN KINGHELM ELECTRONIC CO., LTD.	WWW.DBS666.COM
Model: KH-ZBK200R-6P-GS	0755-83044319