

P. C. B. ZBK-200 SERIES ZBK200R-XXP-XS(15EDG-3. 81(Plug)

specification

1. Rated voltage and current: 300V 8A(CE)
2. Insulation Strength: AC1500V/MIN
3. Insulation Resistance: 500MΩ or more at DC500V
4. Operating Temperature: -40 /+105
5. Twisting force: 0.2N.m/Max
6. Wire size: 14-24AWG
7. Storage condition: Under 85% humidity at normal temperature, shelf life: 1 year.

Materials and dimensions

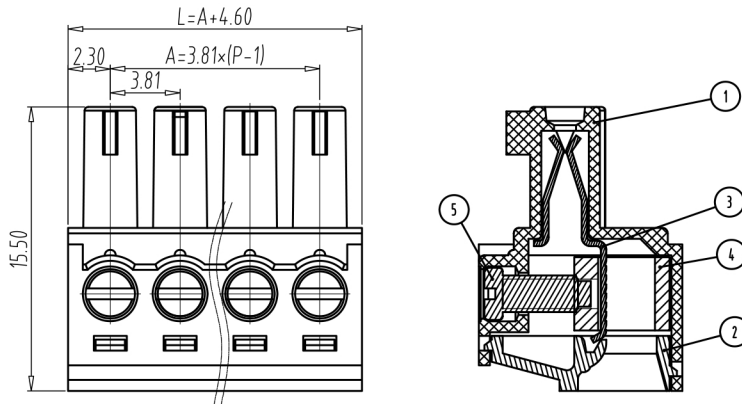

#Use of recycled material ≤ 30%

NO.	Designation	Materials	Specification
1	HOUSING	PA66(UL94V-0)	
2	COVER	PA66(UL94V-0)	
3	CLAMP	BRONZE	EP-Cu/Cu1-2 Ni2-4um
4	BLOCK	BRASS	EP-Cu/Cu1-2 Ni2-4um
5	SCREW	STEEL	M3.0EP-Fe/Cu1-2 Zn5-8um

Type selection

Insertion-withdrawal type(Receptacle)

Serial code	Sequence code	feature code	Identifivng code
ZBK	200R	XXP	XS

Screw specification : s-character
 Colour code :X-(unspecified)
 Qty of cables (XXP unspecified)
 R. Inline direction and insertion Direction level
 Serial number for specification classification
 Spacing code: 2-3.81mm
 ZB- Company Code , K-Insertion-withdrawal type(Plug)

Packaging:
Package size: 20.0×19.0 (cm)

SHENZHEN KINGHELM ELECTRONIC CO., LTD.	WWW.DBS666.COM
Model: KH-ZBK200R-9P-GS	0755-83044319