

Kinghelm®

REVISIONS					
REV	NUMBER	DESCRIPTION	DWN	CHK	DATE
A		DESIGN			

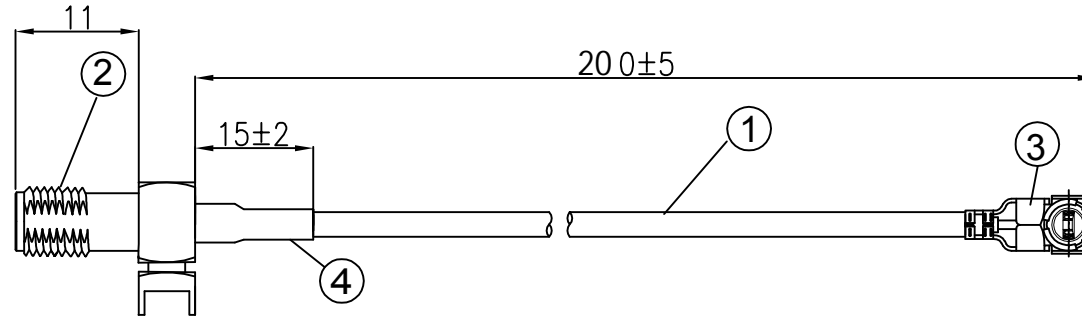

NOTES:

1. ELECTRICAL:
 - 1.1. VOLTAGE RATING:DCV 300V 10MS
 - 1.2. CONDUCTANCE RESISTANCE: 3.0 OHM/MAX.
 - 1.3. INSULATION RESISTANCE: 5.0M OHM/MIN.
 - 1.4. THE CABLE SHOULD BE 100% ELECTRICAL TEST
 - 1.5. IT SHOULD BE NO ANY OPEN/SHORT, MISWIRING AND INTERMITTENT FAILURES.
2. MATERIAL:
 - 2.1. SEE TABLE
3. ALL COMPONENTS ARE RoHS COMPLIANT.

ITEM NO.	PART NUMBER	DESCRIPTION	QTY.
④	套管	黑色热缩套管, OD:2.0MM	AS
③	端子	高仿I-PEX ,1.37端子, 镀金	1
②	接头	SMA母头母针, 带4个脚, 半牙, 镀金	1
①	同轴线	RF1.37黑线,OD:1.37mm	AS

深圳市金航标电子有限公司 WWW.BDS666.COM
 KH-IPEX-SMAKWE-RG137-B200MM 0755-83044319

ALL DIMENSION ARE IN MM	DRAWN James	DATE 2021-10-30	I-PEX 1.37 TO SMA / F L=200mm
	CHKD. Frank	2021-10-30	
	APPD. Scott	2021-10-30	
COMPUTER GENERATED IN SOLIDWORKS			
DO NOT SCALE THIS DRAWING			
PROJECTION	GENERAL TOLERANCE FOR ANGLES		SIZE Number
	± 1°	± 0.3 0.25 0.150	B x.XXX
CUSTOMER P/N:			REV A
			SCALE: Free TYPE SHEET 1 OF 1