

版本 REV.	日期 DATE	ECN NO.	变更内容 DESCRIPTION	制图 DRAWN

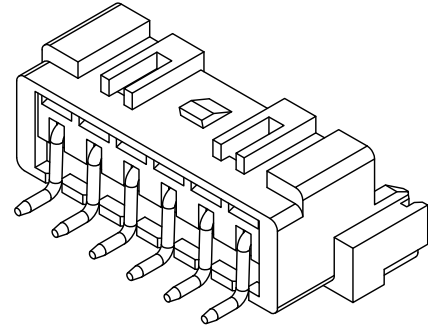
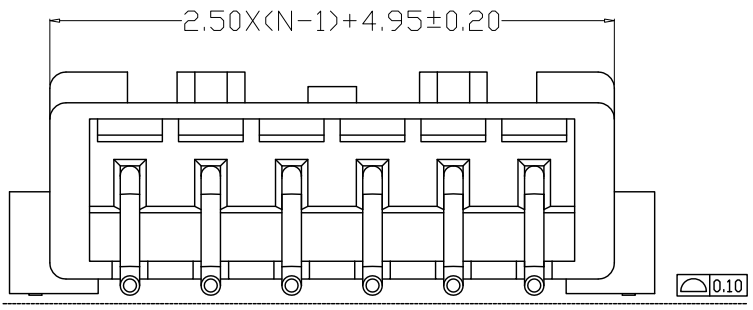

SPECIFICATIONS

- 1、Current Rating: 3A AC, DC
- 2、Voltage Rating: 250V AC, DC
- 3、Temperatuer Range: -25°C~+85°C
- 4、Contact Resistance: 20mΩ Max
- 5、Insulation Resistance: 1000MΩ Min
- 6、Withstanding Voltang: 1000V AC/minute
- 7、Material

Wafer: PA6T UL94V-0
 PIN: C2680 Tin-plated
 Fixed piece: C2680 Tin-plated

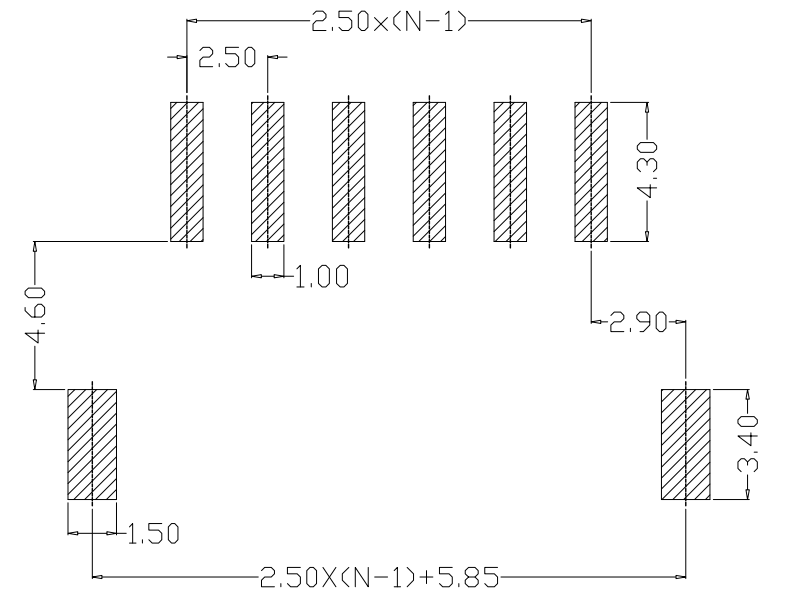
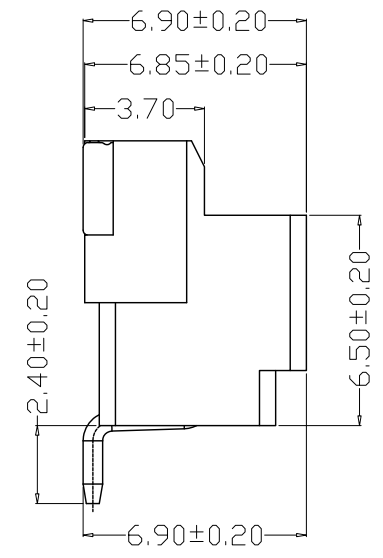
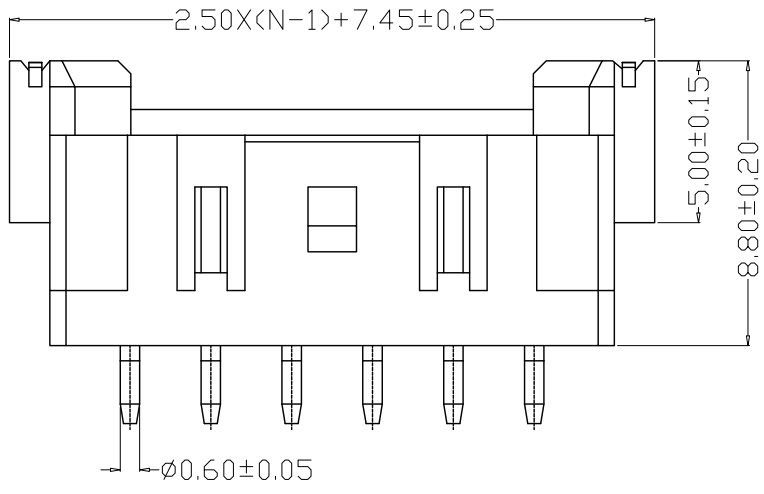

PCB LAYOUT

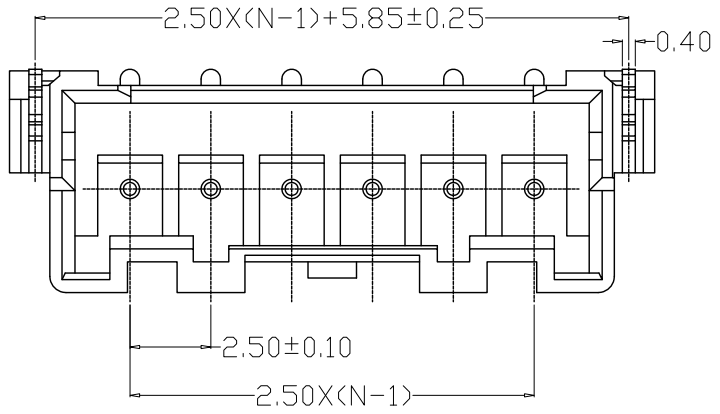

GENERAL TOLERANCE		制图	钱岳生		料号	2508-nAWB	版本	A
X.X±0.25	X.*±2'	DRAWING	2019、01、09		PART NO.	2508-nAWB	REV.	A
X.XXX±0.10		审核	张名		品名	XA贴片	页次	1/1
X.XX±0.20		CHECK	2019、01、10		TITLE	WAFER SMT TYPE	SHEET	
		核准	张名		客户料号			
		APPROVAL	2019、01、10		CUTM. NO.			
		单位	MM	比例	深圳市金航标电子有限公司		www.kinghelm.com.cn	
		UNITS	MM	SCALE	1:1	KH-2508-07AWB	0755-28190160	