

SPECIFICATIONS

- 1、Current Rating: 3A AC, DC
- 2、Voltage Rating: 250V AC, DC
- 3、Temperatuer Range: -25°C~+85°C
- 4、Contact Resistance: 20mΩ Max
- 5、Insulation Resistance: 1000MΩ Min
- 6、Withstanding Voltang: 800V AC/minute
- 7、Material:Wafer PBT,UL94V-0
PIN Brass Tin-plated

编号	尺寸 (mm)	
	A	B
A2026-02AW	2.00	6.00
A2026-03AW	4.00	8.00
A2026-04AW	6.00	10.00
A2026-05AW	8.00	12.00
A2026-06AW	10.00	14.00
A2026-07AW	12.00	16.00
A2026-08AW	14.00	18.00
A2026-09AW	16.00	20.00
A2026-10AW	18.00	22.00
A2026-11AW	20.00	24.00
A2026-12AW	22.00	26.00

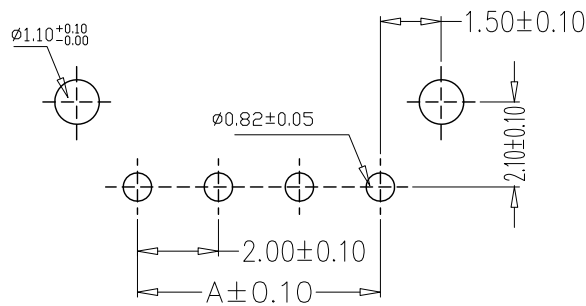
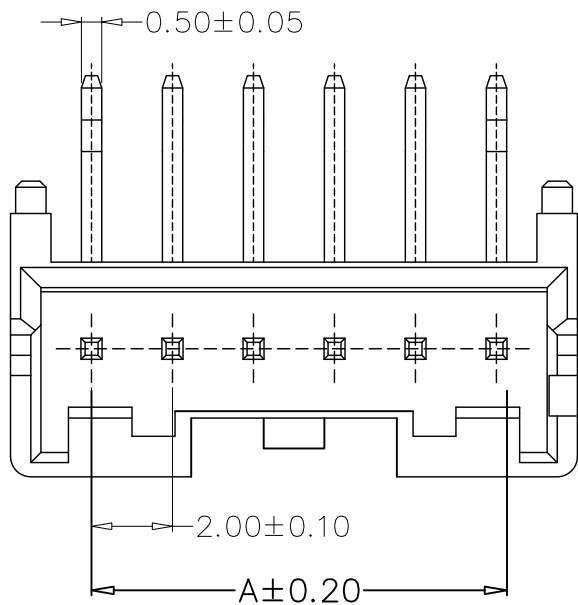

PCB LAYOUT

GENERAL TOLERANCE		制图	钱岳生		料号	A2026-nAWD		版本	A
X±0.25	X*±2'	DRAWING	2021、05、03		PART NO.	PA定位弯针		REV.	1/1
.X±0.20	.X*±1'	审核	张名		品名			SHEET	1/1
.XX±0.15	.XX*±0.5'	CHECK	2021、05、04		客户料号				
.XXX±0.10	.XXX*±0.5'	核准	张名		CUTM. NO.				
		APPROVAL	2021、05、05		深圳市金航标电子有限公司			www.kinghel.com.cn	
		单位	MM	比例	KH-A2026-05AWD		0755-28190160		
		UNITS	MM	SCALE	1:1				