

Kinghelm®

RevNo	Revision note	Date	Signature	Checked
-------	---------------	------	-----------	---------

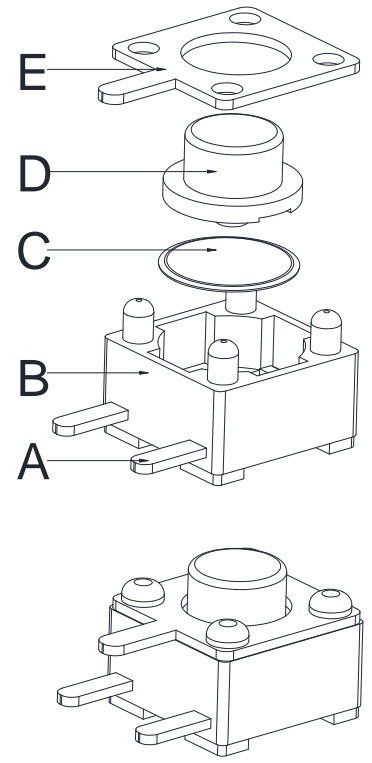
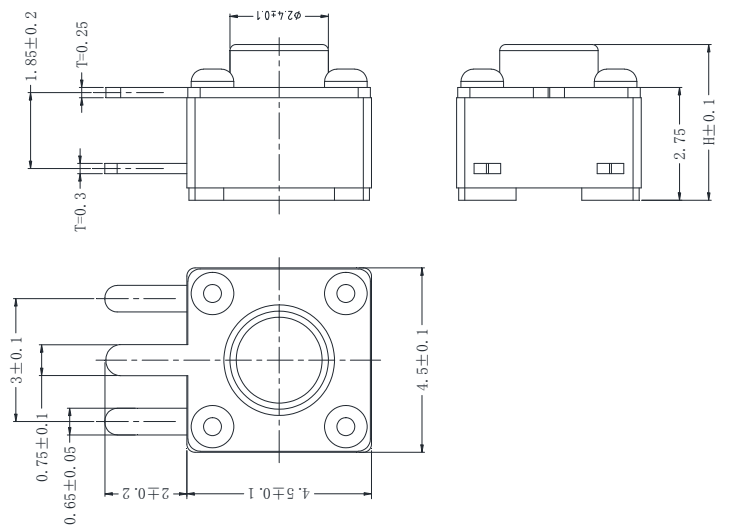

Parameters

- 1.Rated Current: 50mA 12V DC
- 2.Contact Resistance: 100m
- 3.Actuation Force: 160±30gf/260±50gf
- 4.Travel: 0.15±0.05mm
- 5.Insulation Resistance: 100M
- 6.Dielectric Strength:100v 50Hz 1Min
- 7.Lifespan: 50,000 times

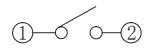

Circuit Diagram

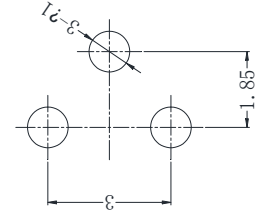

PCB Diagram

										First-person Perspective	Scale	Part No.	4.5x4.5 XH Side Pin
E	Cover	Iron Sheet 0.25	1	Copper-plated tin						General Tolerances	1:1	Product Name	4.5x4.5 Side Pin(2.0)
D	Plunger	PPA Black	1	Purge						>0.5-2 ±0.1	Unit		
C	Contact Dome	SS Cover W/ Silver	1		Mark	Count	Changed File No.	Sig.	Date	>2-5 ±0.2	mm		
B	Base	PPA Black	1	Purge	Designed		Checked		Approved		Shenzhen Kinghelm Electronics Co., Ltd		www.kinghelm.net
A	Contact	Brass 0.3	1	Silver-plated							KH-4.5X4.5X6H-B3J		0755-28190160
SN	Item	Material	Qty.	Note									