

EDITION	CHANGE SUMMARY	DATE	NO.	TITLE	MATERIAL
1	ADD PART NUMBER DESCRIPTION	2015/1/28	①	0.5 Pull Out 3 Generations Of Rubber Core (H2.0)	LCP UL94V-0 True Colour
			②	0.5 Pull Out Vertical Terminals	Copper Alloy / Surface Tin Plating
			③	0.5 Pull Horizontal 3 Generation Rear Cover	LCP UL94V-0 Black
			④	0.5 Pull The 3rd Generation Solder Sheet(H2.0)	Copper Alloy / Surface Tin Plating
			⑤	0.5 Pull Vertical 3 Generation Suction Cap	LCP UL94V-0 Black

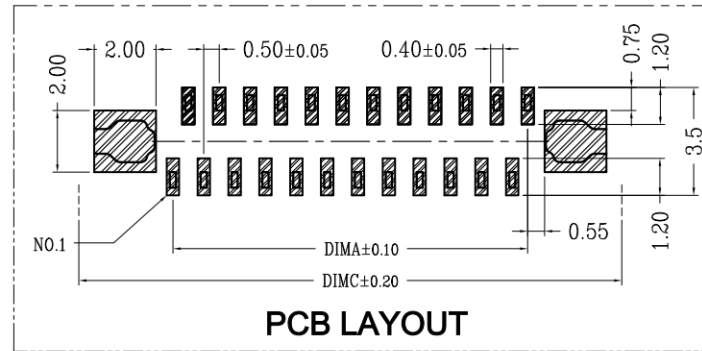
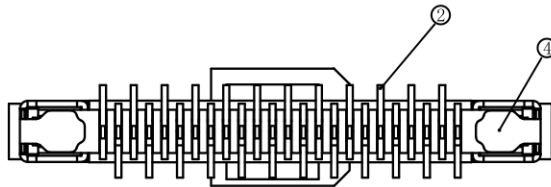
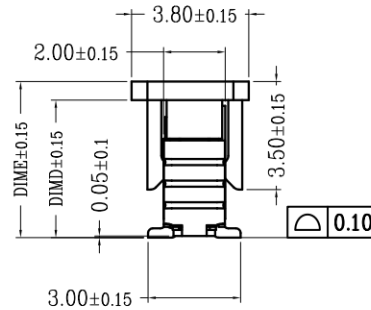
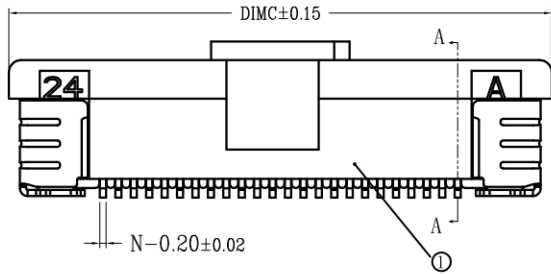
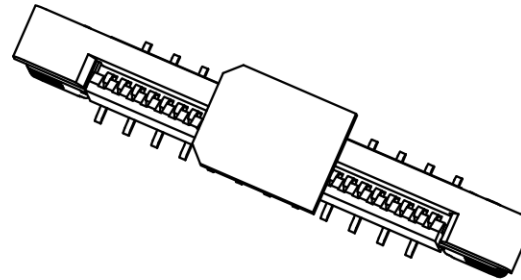
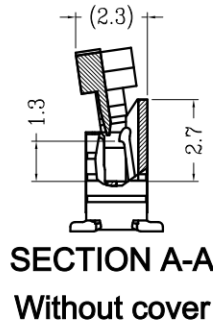
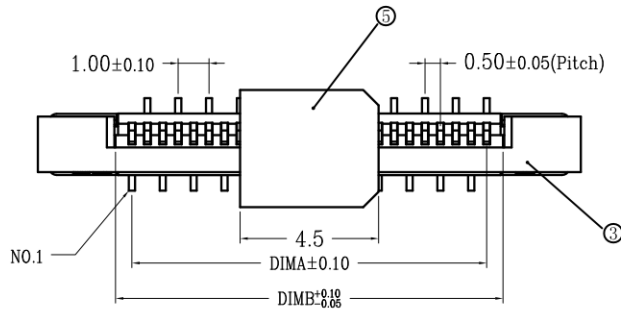

CKT	DIM A	DIM B	DIM C	DIM D	DIM E
6	2.50	3.56	8.60		
7	3.00	4.06	9.10		
8	3.50	4.56	9.60		
9	4.00	5.06	10.10		
10	4.50	5.56	10.60		
11	5.00	6.06	11.10		
12	5.50	6.56	11.60		
13	6.00	7.06	12.10		
14	6.50	7.56	12.60		
15	7.00	8.06	13.10		
16	7.50	8.56	13.60		
17	8.00	9.06	14.10		
18	8.50	9.56	14.60		
19	9.00	10.06	15.10		
20	9.50	10.56	15.60	4.45	5.05
21	10.00	11.06	16.10		
22	10.50	11.56	16.60		
23	11.00	12.06	17.10		
24	11.50	12.56	17.60		
25	12.00	13.06	18.10		
26	12.50	13.56	18.60		
27	13.00	14.06	19.10		
28	13.50	14.56	19.60		
29	14.00	15.06	20.10		
30	14.50	15.56	20.60		
31	15.00	16.06	21.10		
32	15.50	16.56	21.60		
33	16.00	17.06	22.10		
34	16.50	17.56	22.60		

Specification:

1. The surface of the plastic parts should be smooth, hairless, no obvious shrinkage defects, cracks and other phenomena
2. Temperature Range: -25°C~85°C
3. Rated Voltage: 50V, AC/DC (Equivalent)
4. Contact Resistance: ≤0.03Ω
5. Insulation Resistance: ≥500MΩ

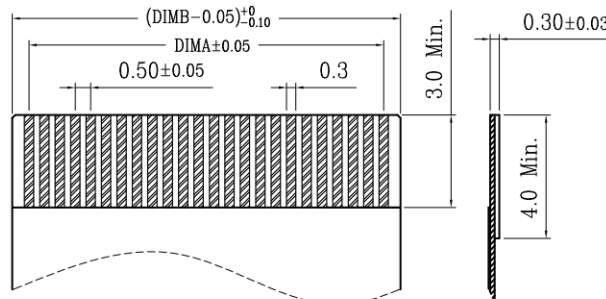

Applicable Flat Cable



TOLERANCE
X±.50 .XX±.10
.X±.20 .XXX±.05
ANGLE ±1°

Shenzhen Kinghelm Electronics Co., Ltd		www.kinghelm.net	
KH-FPC0.5-H5.0-22P-LTQB		0755-28190160	
TITLE	DRAWING		ANLAN
DWG.NO	CHECKED		WT
FP218H-0xxS10M	APPROVED		HZM
SCALE	1:1	UNITS	mm
SHEET		1 OF 1	SIZE/REV
A4		A	