

ZONE	ECN.N.O.	DESCRIPTION	DRAWING	DATE
A		INITIAL	林生财	2020.02.18

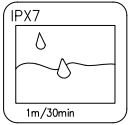

NOTES

1. CURRENT RATING: 1A.
2. CONTACT RESISTANCE: 100mΩ MAX.
3. INSULATION RESISTANCE: 100MΩ MIN.
4. DIELECTRIC WITHSTANDING: 500V AC MIN.
5. DURABILITY: 5000 CYCLES MIN.
6. CONNECTOR MATING FORCES: 3~30N.
7. CONNECTOR UNMATING FORCES: 3~30N.
8. OPERATING TEMPERATURE: -25°C TO +85°C.
9. WATERPROOF LEVEL: IP67

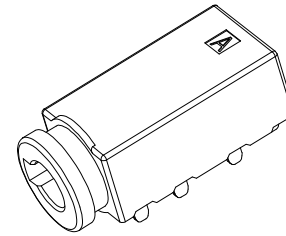

3D VIEW

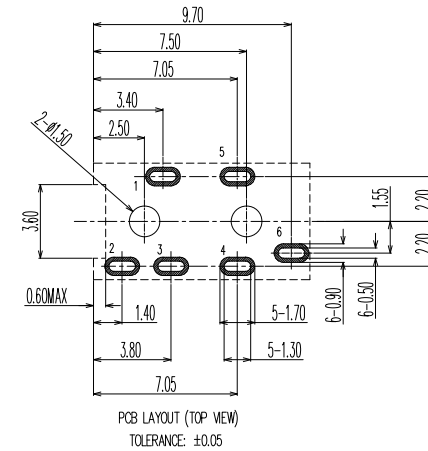
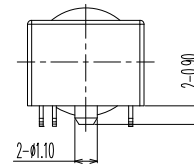
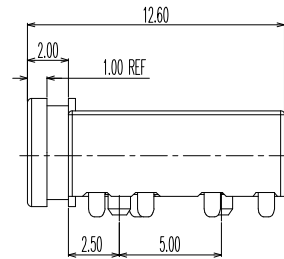
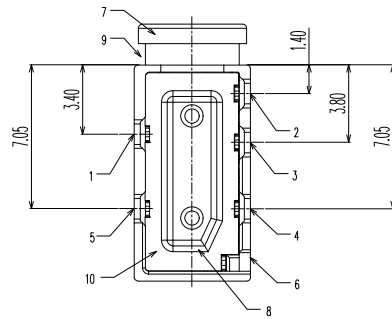
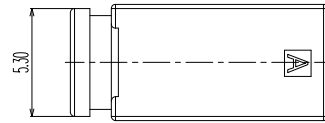
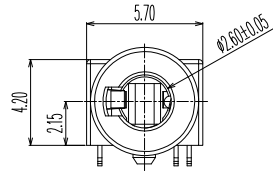

Not to install the waterproof ring shipment

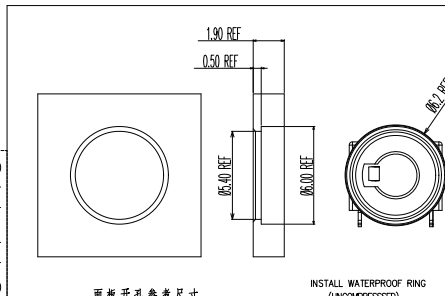
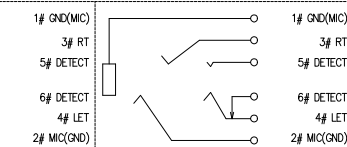
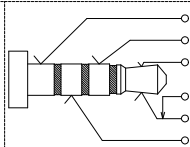
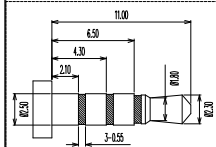

10	GLUE	EPOXY	COLOR BLACK	1
9	WATERPROOF RING	SILICONE	COLOR BLACK	1
8	COVER	HIGH TEMPERATURE	COLOR BLACK	1
7	HOUSING	HIGH TEMPERATURE	COLOR BLACK	1
6	TERMINAL 6#	PHOSPHOR BRONZE	NICKEL UNDERPLATING OVERALL, GOLD FLASH PLATING ON THE SOLDER & CONTACT AREA	1
5	TERMINAL 5#	STAINLESS STEEL	NICKEL UNDERPLATING OVERALL, GOLD FLASH PLATING ON THE SOLDER & CONTACT AREA	1
4	TERMINAL 4#	STAINLESS STEEL	NICKEL UNDERPLATING OVERALL, GOLD FLASH PLATING ON THE SOLDER & CONTACT AREA	1
3	TERMINAL 3#	PHOSPHOR BRONZE	NICKEL UNDERPLATING OVERALL, GOLD FLASH PLATING ON THE SOLDER & CONTACT AREA	1
2	TERMINAL 2#	PHOSPHOR BRONZE	NICKEL UNDERPLATING OVERALL, GOLD FLASH PLATING ON THE SOLDER & CONTACT AREA	1
1	TERMINAL 1#	STAINLESS STEEL	NICKEL UNDERPLATING OVERALL, GOLD FLASH PLATING ON THE SOLDER & CONTACT AREA	1
NO.	DESCRIPTION	MATERIAL	REMARKS	QTY

<p>深圳市金航标电子有限公司</p> <p>SHENZHEN KINGHELM ELECTRON CO.,LTD.</p>		<p>WWW.KINGHELM.COM.CN</p> <p>0755-28190160</p>		<p>DRAWING: 林生财</p> <p>CHECK: 李宏鑫</p> <p>APPROVAL: 杨进宝</p> <p>DRAWING NO. KH-PJ-20002-06DBAP-A</p>		<p>DATE: 2020.02.18</p> <p>DATE: 2020.02.18</p> <p>DATE: 2020.02.18</p>		<p>SCALE: 1:1</p> <p>MATERIAL: *</p> <p>DWG. NO.</p> <p>SHEET: 1/1</p>	
PART NAME	WATERPROOF Ø2.5 PHONE JACK	TOLERANCE UNLESS OTHERWISE SPECIFIED:	0.0±0.25 0.00±0.20 0.000±0.10	0.*±2* 0.0*±1* 0.00*±0.5*	UNIT: mm				