

Kinghelm®

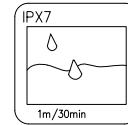

ZONE	E.C.N.O.	DESCRIPTION	DRAWING	DATE
A		INITIAL	林生财	2020.02.18

- NOTES
- CURRENT RATING: 1A.
 - CONTACT RESISTANCE: 100mΩ MAX.
 - INSULATION RESISTANCE: 100MΩ MIN.
 - DIELECTRIC WITHSTANDING: 500V AC MIN.
 - DURABILITY: 5000 CYCLES MIN.
 - CONNECTOR MATING FORCES: 3~30N.
 - CONNECTOR UNMATING FORCES: 3~30NX.
 - SALT SPRAY: 24HOUR
 - WATERPROOF LEVEL: IP67.
 - OPERATING TEMPERATURE: -25°C TO +85°C.

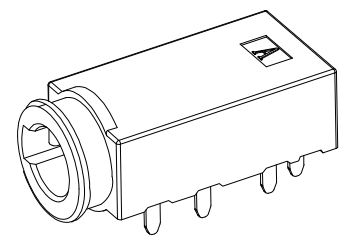

3D VIEW

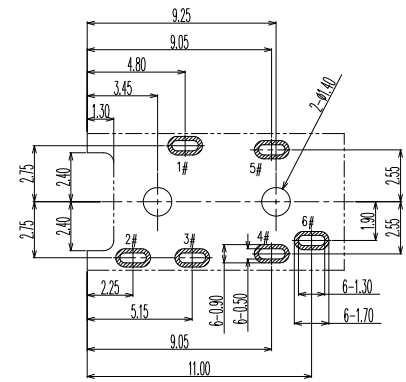
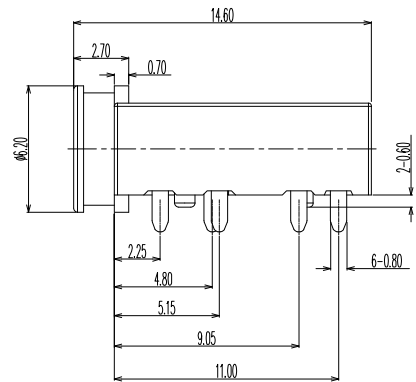

PCB LAYOUT (TOP VIEW)
TOLERANCE: ±0.05

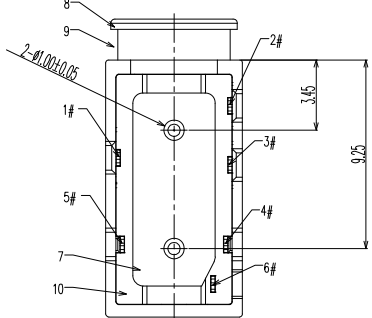
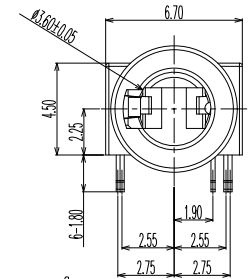
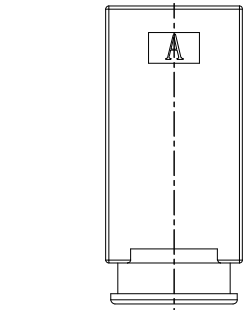

Not to install the waterproof ring shipment

NO.	DESCRIPTION	MATERIAL	REMARKS	QTY
10	GLUE	EPOXY	COLOR BLACK	1
9	WATERPROOF RING	SILICONE	COLOR BLACK	1
8	HOUSING	HIGH TEMPERATURE	COLOR BLACK	1
7	COVER	HIGH TEMPERATURE	COLOR BLACK	1
6	TERMINAL 6#	PHOSPHOR BRONZE	NICKEL UNDERPLATING OVERALL, GOLD FLASH PLATING ON THE SOLDER & CONTACT AREA	1
5	TERMINAL 5#	STAINLESS STEEL	NICKEL UNDERPLATING OVERALL, GOLD FLASH PLATING ON THE SOLDER & CONTACT AREA	1
4	TERMINAL 4#	STAINLESS STEEL	NICKEL UNDERPLATING OVERALL, GOLD FLASH PLATING ON THE SOLDER & CONTACT AREA	1
3	TERMINAL 3#	PHOSPHOR BRONZE	NICKEL UNDERPLATING OVERALL, GOLD FLASH PLATING ON THE SOLDER & CONTACT AREA	1
2	TERMINAL 2#	PHOSPHOR BRONZE	NICKEL UNDERPLATING OVERALL, GOLD FLASH PLATING ON THE SOLDER & CONTACT AREA	1
1	TERMINAL 1#	STAINLESS STEEL	NICKEL UNDERPLATING OVERALL, GOLD FLASH PLATING ON THE SOLDER & CONTACT AREA	1

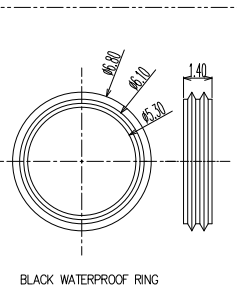
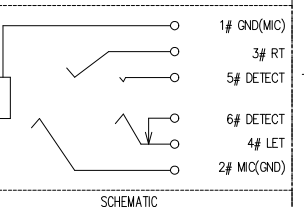
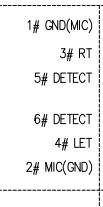
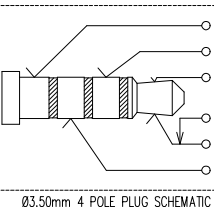
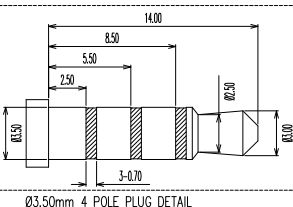

BLACK WATERPROOF RING

深圳市金航标电子有限公司

WWW.KINGHELM.COM.CN
0755-28190160

DRAWING:	林生财	DATE:	2020.02.18	SCALE	1:1
CHECK:	李宏鑫	DATE:	2020.02.18	MATERIAL	*
APPROVAL:	杨进宝	DATE:	2020.02.18	DWG. NO.	
DRAWING NO.	KH-PJ-23003-06DBAP-A			SHEET	1/1

SHENZHEN KINGHELM ELECTRON CO.,LTD.		TOLERANCE UNLESS	0.0±0.25	0.°±2°	UNIT: mm	
PART NAME	WATERPROOF Ø3.5 PHONE JACK	OTHERWISE SPECIFIED:	0.00±0.15	0.0°±1°		
			0.000±0.10	0.00°±0.5°		

F E D C B A