

Kinghelm®

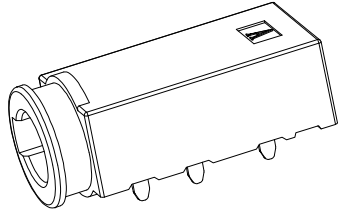

3D VIEW

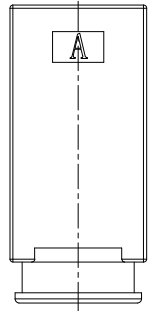
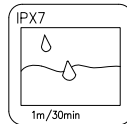

ZONE	EC.N.O.	DESCRIPTION	DRAWING	DATE
A		INITIAL	林生财	2020.02.18

NOTES

- CURRENT RATING: 1A.
- CONTACT RESISTANCE: 100mΩ MAX.
- INSULATION RESISTANCE: 100MΩ MIN.
- DIELECTRIC WITHSTANDING: 500V AC MIN.
- DURABILITY: 5000 CYCLES MIN.
- CONNECTOR MATING FORCES: 3~30N.
- CONNECTOR UNMATING FORCES: 3~30NX.
- SALT SPRAY: 24HOUR
- WATERPROOF LEVEL: IP67.
- OPERATING TEMPERATURE: -25°C TO +85°C.

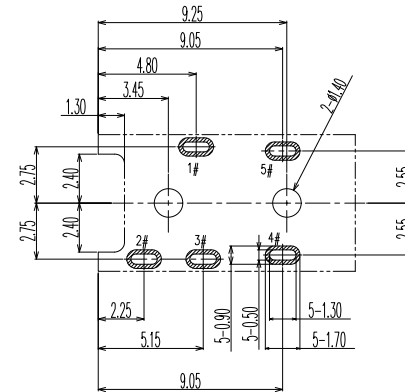
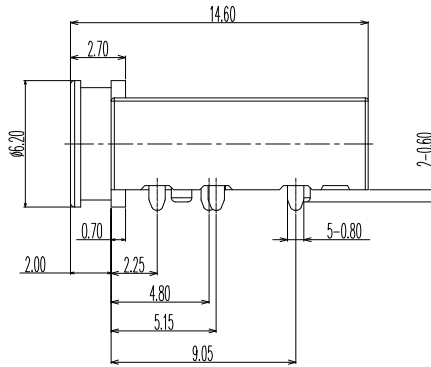
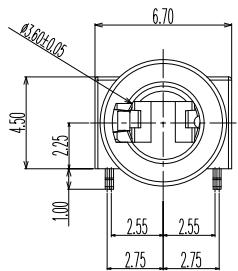

PCB LAYOUT (TOP VIEW)
TOLERANCE: ±0.05

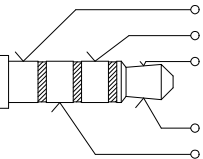
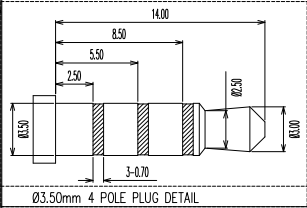
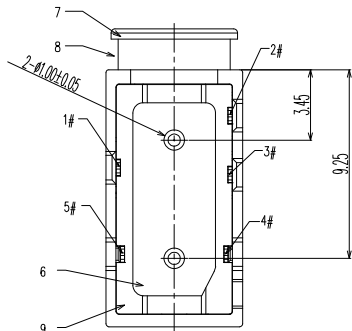

1# GND(MIC)
3# RT
5# DETECT
4# LET
2# MIC(GND)

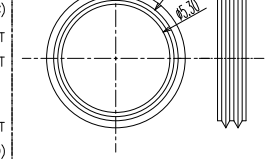
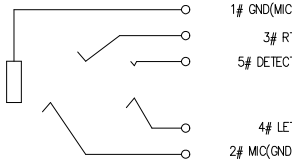

BLACK WATERPROOF RING

NO.	DESCRIPTION	MATERIAL	REMARKS	QTY
9	GLUE	EPOXY	COLOR BLACK	1
8	WATERPROOF RING	SILICONE	COLOR BLACK	1
7	HOUSING	HIGH TEMPERATURE	COLOR BLACK	1
6	COVER	HIGH TEMPERATURE	COLOR BLACK	1
5	TERMINAL 5#	STAINLESS STEEL	NICKEL UNDERPLATING OVERALL, GOLD FLASH PLATING ON THE SOLDER & CONTACT AREA	1
4	TERMINAL 4#	STAINLESS STEEL	NICKEL UNDERPLATING OVERALL, GOLD FLASH PLATING ON THE SOLDER & CONTACT AREA	1
3	TERMINAL 3#	PHOSPHOR BRONZE	NICKEL UNDERPLATING OVERALL, GOLD FLASH PLATING ON THE SOLDER & CONTACT AREA	1
2	TERMINAL 2#	PHOSPHOR BRONZE	NICKEL UNDERPLATING OVERALL, GOLD FLASH PLATING ON THE SOLDER & CONTACT AREA	1
1	TERMINAL 1#	STAINLESS STEEL	NICKEL UNDERPLATING OVERALL, GOLD FLASH PLATING ON THE SOLDER & CONTACT AREA	1

Not to install the waterproof ring shipment

深圳市金航标电子有限公司

WWW.KINGHELM.COM.CN
0755-28190160

DRAWING:	林生财	DATE:	2020.02.18	SCALE:	1:1
CHECK:	李宏鑫	DATE:	2020.02.18	MATERIAL:	*
APPROVAL:	杨进宝	DATE:	2020.02.18	DWG. NO.:	
DRAWING NO.:	KH-PJ-23004-05DBAP-A			SHEET:	1/1

PART NAME	WATERPROOF Ø3.5 PHONE JACK	TOLERANCE UNLESS	0.0±0.25	0.1±2*	UNIT:	mm
		OTHERWISE SPECIFIED:	0.00±0.15 0.000±0.10	0.0*±1* 0.00*±0.5*		