

Kinghelm®

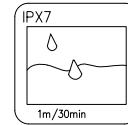

ZONE	EC.N.O.	DESCRIPTION	DRAWING	DATE
A		INITIAL	林生财	2020.02.18

- NOTES
1. CURRENT RATING: 1A.
 2. CONTACT RESISTANCE: 100mΩ MAX.
 3. INSULATION RESISTANCE: 100MΩ MIN.
 4. DIELECTRIC WITHSTANDING: 500V AC MIN.
 5. DURABILITY: 5000 CYCLES MIN.
 6. CONNECTOR MATING FORCES: 3~30N.
 7. CONNECTOR UNMATING FORCES: 3~30NX.
 8. SALT SPRAY: 24HOUR
 9. WATERPROOF LEVEL: IP67.
 10. OPERATING TEMPERATURE: -25°C TO +85°C.

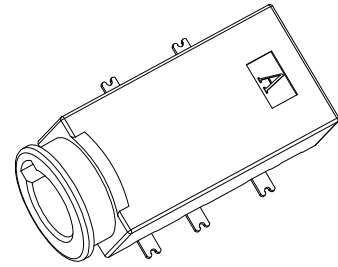
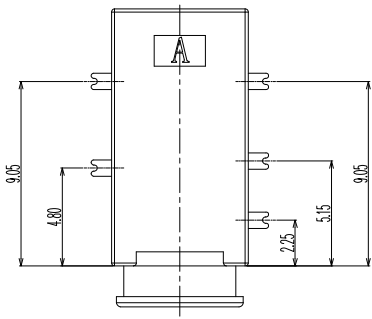

3D VIEW

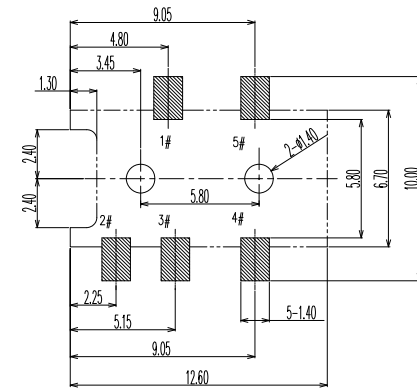
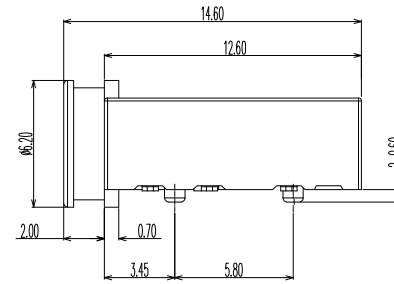
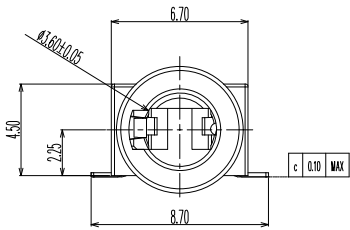

PCB LAYOUT (TOP VIEW)
TOLERANCE: ±0.05

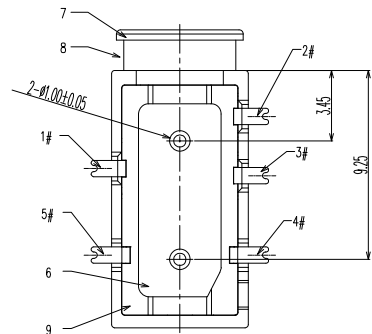

Not to install the waterproof ring shipment

9	GLUE	EPOXY	COLOR BLACK	1
8	WATERPROOF RING	SILICONE	COLOR BLACK	1
7	HOUSING	HIGH TEMPERATURE	COLOR BLACK	1
6	COVER	HIGH TEMPERATURE	COLOR BLACK	1
5	TERMINAL 5#	STAINLESS STEEL	NICKEL UNDERPLATING OVERALL, GOLD FLASH PLATING ON THE SOLDER & CONTACT AREA	1
4	TERMINAL 4#	STAINLESS STEEL	NICKEL UNDERPLATING OVERALL, GOLD FLASH PLATING ON THE SOLDER & CONTACT AREA	1
3	TERMINAL 3#	PHOSPHOR BRONZE	NICKEL UNDERPLATING OVERALL, GOLD FLASH PLATING ON THE SOLDER & CONTACT AREA	1
2	TERMINAL 2#	PHOSPHOR BRONZE	NICKEL UNDERPLATING OVERALL, GOLD FLASH PLATING ON THE SOLDER & CONTACT AREA	1
1	TERMINAL 1#	STAINLESS STEEL	NICKEL UNDERPLATING OVERALL, GOLD FLASH PLATING ON THE SOLDER & CONTACT AREA	1
NO.	DESCRIPTION	MATERIAL	REMARKS	QTY

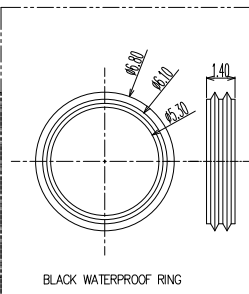
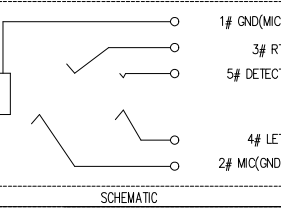
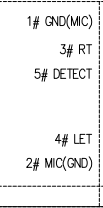
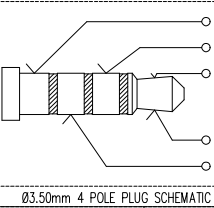
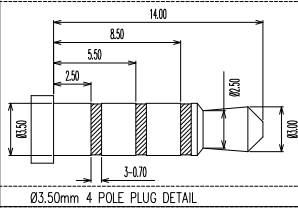

BLACK WATERPROOF RING

深圳市金航标电子有限公司

WWW.KINGHELM.COM.CN
0755-28190160

DRAWING:	林生财	DATE:	2020.02.18	SCALE	1:1
CHECK:	李宏鑫	DATE:	2020.02.18	MATERIAL	*
APPROVAL:	杨进宝	DATE:	2020.02.18	DWG. NO.	
DRAWING NO.	KH-PJ-23005-05SBAP-A			SHEET	1/1

SHENZHEN KINGHELM ELECTRON CO.,LTD.
PART NAME WATERPROOF Ø3.5 PHONE JACK

TOLERANCE UNLESS OTHERWISE SPECIFIED:
0.0±0.25
0.00±0.15
0.000±0.10
0.°±2°
0.0°±1°
0.00°±0.5°

UNIT: mm

