

Kinghelm®

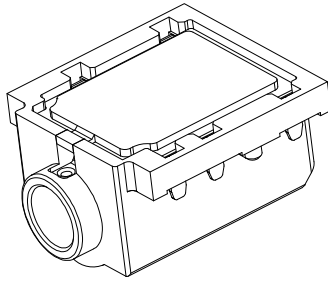

3D VIEW

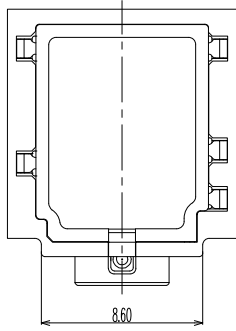
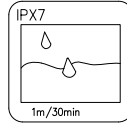

ZONE	EC.N.O.	DESCRIPTION	DRAWING	DATE
A		INITIAL	林生财	2020.02.18

NOTES

- CURRENT RATING: 1A.
- CONTACT RESISTANCE: 100mΩ MAX.
- INSULATION RESISTANCE: 100MΩ MIN.
- DIELECTRIC WITHSTANDING: 500V AC MIN.
- DURABILITY: 5000 CYCLES MIN.
- CONNECTOR MATING FORCES: 3~30N.
- CONNECTOR UNMATING FORCES: 3~30N.
- OPERATING TEMPERATURE: -25°C TO +85°C.
- WATERPROOF LEVEL: IP67

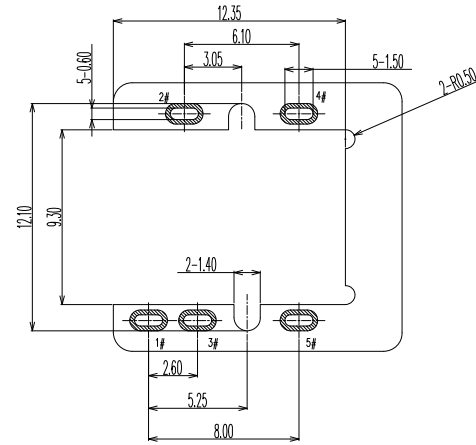
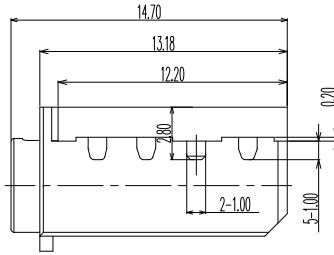
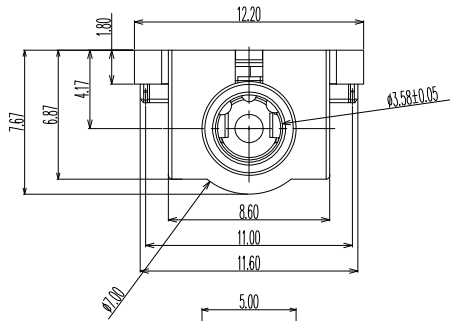

PCB LAYOUT (TOP VIEW)
TOLERANCE: ±0.05

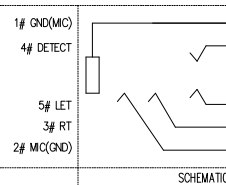
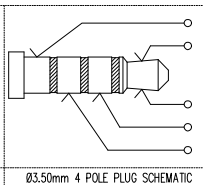
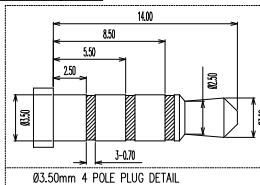
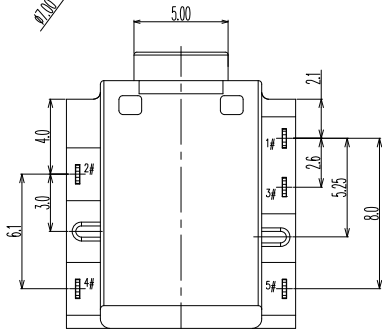

8	GLUE	EPOXY	COLOR BLACK	1
7	COVER	HIGH TEMPERATURE	COLOR BLACK	1
6	HOUSING	HIGH TEMPERATURE	COLOR BLACK	1
5	TERMINAL 5#	STAINLESS STEEL	NICKEL UNDERPLATING OVERALL, GOLD FLASH PLATING ON SOLDER & CONTACT AREA	1
4	TERMINAL 4#	STAINLESS STEEL	NICKEL UNDERPLATING OVERALL, GOLD FLASH PLATING ON SOLDER & CONTACT AREA	1
3	TERMINAL 3#	STAINLESS STEEL	NICKEL UNDERPLATING OVERALL, GOLD FLASH PLATING ON SOLDER & CONTACT AREA	1
2	TERMINAL 2#	STAINLESS STEEL	NICKEL UNDERPLATING OVERALL, GOLD FLASH PLATING ON SOLDER & CONTACT AREA	1
1	TERMINAL 1#	STAINLESS STEEL	NICKEL UNDERPLATING OVERALL, GOLD FLASH PLATING ON SOLDER & CONTACT AREA	1
NO.	DESCRIPTION	MATERIAL	REMARKS	QTY

深圳市金航标电子有限公司

WWW.KINGHELM.COM.CN

0755-28190160

SHENZHEN KINGHELM ELECTRON CO.,LTD.

TOLERANCE UNLESS
OTHERWISE SPECIFIED:

0.0±0.25
0.00±0.15
0.000±0.10

UNIT:
mm



DRAWING:	林生财	DATE:	2020.02.18	SCALE	1:1
CHECK:	李宏鑫	DATE:	2020.02.18	MATERIAL	*
APPROVAL:	杨进宝	DATE:	2020.02.18	DWG. NO.	
DRAWING NO.	KH-PJ-23007-05DBAP-A			SHEET	1/1

PART NAME

WATERPROOF Ø3.5 PHONE JACK